

EOS HD Laparoscopes

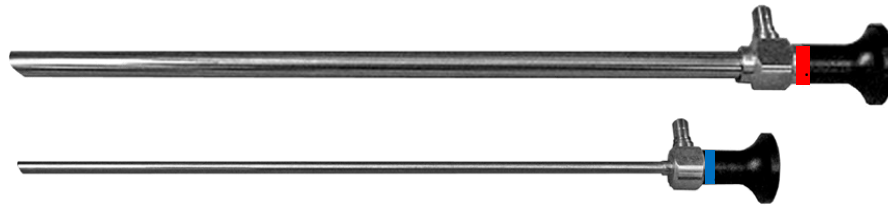

ITEM NO.	SIZE	DESCRIPTION
52205-00	5MM X 26CM	0° LAPAROSCOPE, HD, AUTOCLAVABLE, COLOR CODE: BLUE
52205-01	5MM X 26CM	30° LAPAROSCOPE, HD, AUTOCLAVABLE, COLOR CODE: RED
52205-02	5MM X 30CM	0° LAPAROSCOPE, HD, AUTOCLAVABLE, COLOR CODE: BLUE
52205-03	5MM X 30CM	30° LAPAROSCOPE, HD, AUTOCLAVABLE, COLOR CODE: RED
52205-04	5MM X 30CM	45° LAPAROSCOPE, HD, AUTOCLAVABLE, COLOR CODE: BLACK
52215-00	5MM X 50CM	0° LAPAROSCOPE, HD, AUTOCLAVABLE, COLOR CODE: BLUE
52215-01	5MM X 50CM	30° LAPAROSCOPE, HD, AUTOCLAVABLE, COLOR CODE: RED
52215-02	5MM X 50CM	45° LAPAROSCOPE, HD, AUTOCLAVABLE, COLOR CODE: BLACK
52210-00	10MM X 30CM	0° LAPAROSCOPE, HD, AUTOCLAVABLE, COLOR CODE: BLUE
52210-01	10MM X 30CM	30° LAPAROSCOPE, HD, AUTOCLAVABLE, COLOR CODE: RED
52210-02	10MM X 30CM	45° LAPAROSCOPE, HD, AUTOCLAVABLE, COLOR CODE: BLACK
52215-00	10MM X 50CM	0° LAPAROSCOPE, HD, AUTOCLAVABLE, COLOR CODE: BLUE
52215-01	10MM X 50CM	30° LAPAROSCOPE, HD, AUTOCLAVABLE, COLOR CODE: RED
52215-02	10MM X 50CM	45° LAPAROSCOPE, HD, AUTOCLAVABLE, COLOR CODE: BLACK

EOS HD Operating Laparoscopes



LIST NO.	DESCRIPTION
52110-01	0 DEGREE, 10 MM Ø, RIGHT ANGLE EYE PIECE, 3 MM INSTRUMENT CHANNEL
52110-02	0 DEGREE VIEWING, 10 MM Ø, 45 DEGREE ANGLE EYE PIECE, 3 MM INSTRUMENT CHANNEL.
52110-03	0 DEGREE VIEWING, 10 MM Ø, RIGHT ANGLE EYE PIECE, 5.5 MM INSTRUMENT CHANNEL
52110-04	0 DEGREE VIEWING, 11 MM Ø, 45 DEGREE ANGLE EYE PIECE, 6 MM INSTRUMENT CHANNEL
52110-05	0 DEGREE VIEWING, 11 MM Ø, RIGHT ANGLE EYE PIECE, 6 MM INSTRUMENT CHANNEL
52110-06	0 DEGREE VIEWING, 12 MM Ø, RIGHT ANGLE EYE PIECE, 7 MM INSTRUMENT CHANNEL
52110-07	0 DEGREE VIEWING, 12 MM Ø, 45 DEGREE ANGLE EYE PIECE, 7 MM INSTRUMENT CHANNEL
52110-08	0 DEGREE VIEWING, 10 MM Ø, 45 DEGREE ANGLE EYE PIECE, 5.5 MM INSTRUMENT CHANNEL

One Piece Rotatable Laparoscopic Instruments



BASIN SERIES:

ROTATABLE ONE-PIECE INSTRUMENT WITH FLUSH PORT



HANDLES: Insulated & Carbon Fiber

52555-40-01

INSULATED STAINLESS STEEL
W/ RF POST
(TYPE 1)



52555-40-02

INSULATED STAINLESS STEEL
W/ RF-POST & RATCHET
(TYPE 2)



52555-40-05

INSULATED W/ RF-POST &
RATCHET (TYPE 5)



52555-40-06

LIGHTWEIGHT CARBON
FIBER W/ RF-POST & RATCHET
(TYPE 6)



52555-40-07

LIGHTWEIGHT CARBON-FIBER
W/ RF POST,
RATCHET / RATCHET
DEFEATING (TYPE 7)



52555-40-08

LIGHTWEIGHT CARBON-FIBER
W/ RF POST, ON DEMAND
FRENCH ON/OFF RATCHET
(TYPE 8)



52555-40-09

LIGHTWEIGHT CARBON-FIBER
W/ RF POST, W/ LARGE FINGER
LOOPS
(TYPE 9)



52555-40-10

LIGHTWEIGHT
CARBON-FIBER W/ RF POST,
RATCHET / RATCHET
DEFEATING W/ LARGE FINGER
LOOPS (TYPE 10)



52555-40-14

INSULATED STAINLESS STEEL
LINVATEC-WECK STYLE W/
LONG SHANKS (TYPE 14)



52555-40-17

LIGHTWEIGHT THERMOS-
PLASTIC W/ RF POST
(TYPE 17)



52555-40-18

LIGHTWEIGHT THERMOS-
PLASTIC W/ RF POST,
RATCHET / RATCHET
DEFEATING (TYPE 18)



52555-40-23

LIGHTWEIGHT THERMO-
PLASTIC W/ RF POST,
NON-RATCHET (TYPE 23)



52555-40-24

LIGHTWEIGHT THERMO-
PLASTIC W/ RF POST,
W/ RATCHET (TYPE 24)





HANDLES: Non-Insulated

52555-40-03

NON-INSULATED
STAINLESS STEEL
(TYPE 3)



52555-40-15

NON-INSULATED STAINLESS
STEEL LINVATEC-WECK STYLE
W/ QUICK RELEASE RATCHET &
LONG SHANKS (TYPE 15)



52555-40-04

NON-INSULATED
STAINLESS STEEL W/ RATCHET
(TYPE 4)



52555-40-16

NON-INSULATED STAINLESS
STEEL W/ SPRING ASSIST
CLOSING (TYPE 16)



52555-40-11

NON-INSULATED RING AXIAL
HANDLE (TYPE 11)



52555-40-13

STAINLESS STEEL AXIAL
HANDLE W/ PRECISE
ENGAGEMENT RATCHET
(TYPE 13)



52555-40-12

NON-INSULATED RING
AXIAL HANDLE W/
RATCHET (TYPE 12)















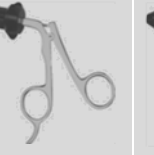

STYLE B:

ROTATABLE, ONE-PIECE INSTRUMENT WITH FLUSH PORT



Dissectors & Graspers







TIP ID.	DIAMETER	LENGTH	52555-40-01	52555-40-17	52555-40-18	52555-40-10	52555-40-03	52555-40-04
								
			INSULATED & CARBON FIBER HANDLES				NON-INSULATED HANDLES	
 MICRO REDDICK OLSEN 12MM	5MM	24CM	52224-01B1	52224-01B17	52224-01B18	52224-01B10	52224-01B3	52224-01B4
	5MM	33CM	52255-01B1	52255-01B17	52255-01B18	52255-01B10	52255-01B3	52255-01B4
	5MM	36CM	52236-01B1	52236-01B17	52236-01B18	52236-01B10	52236-01B3	52236-01B4
	5MM	45CM	52155-01B1	52155-01B17	52155-01B18	52155-01B10	52155-01B3	52155-01B4
 STANDARD GRASPER W/ SPOON 12MM TIP	5MM	24CM	52224-02B1	52224-02B17	52224-02B18	52224-02B10	52224-02B3	52224-02B4
	5MM	33CM	52255-02B1	52255-02B17	52255-02B18	52255-02B10	52255-02B3	52255-02B4
	5MM	36CM	52236-02B1	52236-02B17	52236-02B18	52236-02B10	52236-02B3	52236-02B4
	5MM	45CM	52155-02B1	52155-02B17	52155-02B18	52155-02B10	52155-02B3	52155-02B4
 STANDARD GRASPER W/ SPOON, LONG 20MM TIP	5MM	24CM	52224-52B1	52224-52B17	52224-52B18	52224-52B10	52224-52B3	52224-52B4
	5MM	33CM	52255-52B1	52255-52B17	52255-52B18	52255-52B10	52255-52B3	52255-52B4
	5MM	36CM	52236-52B1	52236-52B17	52236-52B18	52236-52B10	52236-52B3	52236-52B4
	5MM	45CM	52155-52B1	52155-52B17	52155-52B18	52155-52B10	52155-52B3	52155-52B4
 STANDARD GRASPER 12MM TIP	5MM	24CM	52224-03B1	52224-03B17	52224-03B18	52224-03B10	52224-03B3	52224-03B4
	5MM	33CM	52255-03B1	52255-03B17	52255-03B18	52255-03B10	52255-03B3	52255-03B4
	5MM	36CM	52236-03B1	52236-03B17	52236-03B18	52236-03B10	52236-03B3	52236-03B4
	5MM	45CM	52155-03B1	52155-03B17	52155-03B18	52155-03B10	52155-03B3	52155-03B4
 BULLET-NOSE GRASPER W/ SPOON 12MM TIP	5MM	24CM	52224-04B1	52224-04B17	52224-04B18	52224-04B10	52224-04B3	52224-04B4
	5MM	33CM	52255-04B1	52255-04B17	52255-04B18	52255-04B10	52255-04B3	52255-04B4
	5MM	36CM	52236-04B1	52236-04B17	52236-04B18	52236-04B10	52236-04B3	52236-04B4
	5MM	45CM	52155-04B1	52155-04B17	52155-04B18	52155-04B10	52155-04B3	52155-04B4
 TAPERED DOLPHIN-NOSE 15MM TIP	5MM	24CM	52224-05B1	52224-05B17	52224-05B18	52224-05B10	52224-05B3	52224-05B4
	5MM	33CM	52255-05B1	52255-05B17	52255-05B18	52255-05B10	52255-05B3	52255-05B4
	5MM	36CM	52236-05B1	52236-05B17	52236-05B18	52236-05B10	52236-05B3	52236-05B4
	5MM	45CM	52155-05B1	52155-05B17	52155-05B18	52155-05B10	52155-05B3	52155-05B4



STYLE B:

ROTATABLE, ONE-PIECE INSTRUMENT WITH FLUSH PORT

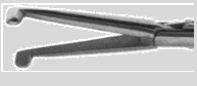
Dissectors & Graspers

TIP ID.	DIAMETER	LENGTH	52555-40-01	52555-40-17	52555-40-18	52555-40-10	52555-40-03	52555-40-04
			INSULATED & CARBON FIBER HANDLES				NON-INSULATED HANDLES	
 15MM TIP	5MM	24CM	52224-105B1	52224-105B17	52224-105B18	52224-105B10	52224-105B3	52224-105B4
	5MM	33CM	52255-105B1	52255-105B17	52255-105B18	52255-105B10	52255-105B3	52255-105B4
	5MM	36CM	52236-105B1	52236-105B17	52236-105B18	52236-105B10	52236-105B3	52236-105B4
	5MM	45CM	52155-105B1	52155-105B17	52155-105B18	52155-105B10	52155-105B3	52155-105B4
 18MM TIP	5MM	24CM	52224-06B1	52224-06B17	52224-06B18	52224-06B10	52224-06B3	52224-06B4
	5MM	33CM	52255-06B1	52255-06B17	52255-06B18	52255-06B10	52255-06B3	52255-06B4
	5MM	36CM	52236-06B1	52236-06B17	52236-06B18	52236-06B10	52236-06B3	52236-06B4
	5MM	45CM	52155-06B1	52155-06B17	52155-06B18	52155-06B10	52155-06B3	52155-06B4
	10MM	33CM	52102-06B1	52102-06B17	52102-06B18	52102-06B10	52102-06B3	52102-06B4
	10MM	36CM	52103-06B1	52103-06B17	52103-06B18	52103-06B10	52103-06B3	52103-06B4
 18MM TIP	5MM	24CM	52224-106B1	52224-106B17	52224-106B18	52224-106B10	52224-106B3	52224-106B4
	5MM	33CM	52255-106B1	52255-106B17	52255-106B18	52255-106B10	52255-106B3	52255-106B4
	5MM	36CM	52236-106B1	52236-106B17	52236-106B18	52236-106B10	52236-106B3	52236-106B4
	5MM	45CM	52155-106B1	52155-106B17	52155-106B18	52155-106B10	52155-106B3	52155-106B4
 15MM TIP	5MM	24CM	52224-206B1	52224-206B17	52224-206B18	52224-206B10	52224-206B3	52224-206B4
	5MM	33CM	52255-206B1	52255-206B17	52255-206B18	52255-206B10	52255-206B3	52255-206B4
	5MM	36CM	52236-206B1	52236-206B17	52236-206B18	52236-206B10	52236-206B3	52236-206B4
	5MM	45CM	52155-206B1	52155-206B17	52155-206B18	52155-206B10	52155-206B3	52155-206B4
 22MM TIP	5MM	24CM	52224-07B1	52224-07B17	52224-07B18	52224-07B10	52224-07B3	52224-07B4
	5MM	33CM	52255-07B1	52255-07B17	52255-07B18	52255-07B10	52255-07B3	52255-07B4
	5MM	36CM	52236-07B1	52236-07B17	52236-07B18	52236-07B10	52236-07B3	52236-07B4
	5MM	45CM	52155-07B1	52155-07B17	52155-07B18	52155-07B10	52155-07B3	52155-07B4
	10MM	33CM	52102-07B1	52102-07B17	52102-07B18	52102-07B10	52102-07B3	52102-07B4
	10MM	36CM	52103-07B1	52103-07B17	52103-07B18	52103-07B10	52103-07B3	52103-07B4
 12MM TIP	5MM	24CM	52224-59B1	52224-59B17	52224-59B18	52224-59B10	52224-59B3	52224-59B4
	5MM	33CM	52255-59B1	52255-59B17	52255-59B18	52255-59B10	52255-59B3	52255-59B4
	5MM	36CM	52236-59B1	52236-59B17	52236-59B18	52236-59B10	52236-59B3	52236-59B4
	5MM	45CM	52155-59B1	52155-59B17	52155-59B18	52155-59B10	52155-59B3	52155-59B4
	10MM	33CM	52102-59B1	52102-59B17	52102-59B18	52102-59B10	52102-59B3	52102-59B4
	10MM	36CM	52103-59B1	52103-59B17	52103-59B18	52103-59B10	52103-59B3	52103-59B4









STYLE B:

ROTATABLE, ONE-PIECE INSTRUMENT WITH FLUSH PORT



Dissectors & Graspers

TIP ID.	DIAMETER	LENGTH	52555-40-01	52555-40-17	52555-40-18	52555-40-10	52555-40-03	52555-40-04
			INSULATED & CARBON FIBER HANDLES				NON-INSULATED HANDLES	
 PETELIN DISSECTOR, 30 DEGREE ANGLE, SA 10MM TIP	5MM	24CM	52224-13B1	52224-13B17	52224-13B18	52224-13B10	52224-13B3	52224-13B4
	5MM	33CM	52255-13B1	52255-13B17	52255-13B18	52255-13B10	52255-13B3	52255-13B4
	5MM	36CM	52236-13B1	52236-13B17	52236-13B18	52236-13B10	52236-13B3	52236-13B4
	5MM	45CM	52155-13B1	52155-13B17	52155-13B18	52155-13B10	52155-13B3	52155-13B4
 MICRO GRASPER, FENESTRATED 10MM TIP	5MM	24CM	52224-14B1	52224-14B17	52224-14B18	52224-14B10	52224-14B3	52224-14B4
	5MM	33CM	52255-14B1	52255-14B17	52255-14B18	52255-14B10	52255-14B3	52255-14B4
	5MM	36CM	52236-14B1	52236-14B17	52236-14B18	52236-14B10	52236-14B3	52236-14B4
	5MM	45CM	52155-14B1	52155-14B17	52155-14B18	52155-14B10	52155-14B3	52155-14B4
 COBRA GRASPER, DOUBLE-ACTION 10MM TIP	5MM	24CM	52224-15B1	52224-15B17	52224-15B18	52224-15B10	52224-15B3	52224-15B4
	5MM	33CM	52255-15B1	52255-15B17	52255-15B18	52255-15B10	52255-15B3	52255-15B4
	5MM	36CM	52236-15B1	52236-15B17	52236-15B18	52236-15B10	52236-15B3	52236-15B4
	5MM	45CM	52155-15B1	52155-15B17	52155-15B18	52155-15B10	52155-15B3	52155-15B4
 BABCOCK GRASPER, FENESTRATED TIP 30MM TIP	5MM	24CM	52224-16B1	52224-16B17	52224-16B18	52224-16B10	52224-16B3	52224-16B4
	5MM	33CM	52255-16B1	52255-16B17	52255-16B18	52255-16B10	52255-16B3	52255-16B4
	5MM	36CM	52236-16B1	52236-16B17	52236-16B18	52236-16B10	52236-16B3	52236-16B4
	5MM	45CM	52155-16B1	52155-16B17	52155-16B18	52155-16B10	52155-16B3	52155-16B4
	10MM	33CM	52102-16B1	52102-16B17	52102-16B18	52102-16B10	52102-16B3	52102-16B4
	10MM	36CM	52103-16B1	52103-16B17	52103-16B18	52103-16B10	52103-16B3	52103-16B4
 BABCOCK GRASPER, AXIS STYLE, FENESTRATED 30MM TIP	5MM	24CM	52224-116B1	52224-116B17	52224-116B18	52224-116B10	52224-116B3	52224-116B4
	5MM	33CM	52255-116B1	52255-116B17	52255-116B18	52255-116B10	52255-116B3	52255-116B4
	5MM	36CM	52236-116B1	52236-116B17	52236-116B18	52236-116B10	52236-116B3	52236-116B4
	5MM	45CM	52155-116B1	52155-116B17	52155-116B18	52155-116B10	52155-116B3	52155-116B4
 BABCOCK GRASPER, SHORT DELICATE 20MM TIP	5MM	24CM	52224-17B1	52224-17B17	52224-17B18	52224-17B10	52224-17B3	52224-17B4
	5MM	33CM	52255-17B1	52255-17B17	52255-17B18	52255-17B10	52255-17B3	52255-17B4
	5MM	36CM	52236-17B1	52236-17B17	52236-17B18	52236-17B10	52236-17B3	52236-17B4
	5MM	45CM	52155-17B1	52155-17B17	52155-17B18	52155-17B10	52155-17B3	52155-17B4





STYLE B:

ROTATABLE, ONE-PIECE INSTRUMENT WITH FLUSH PORT

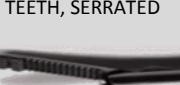
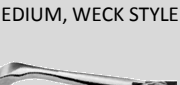
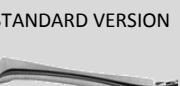

Dissectors & Graspers

TIP ID.	DIAMETER	LENGTH	52555-40-01	52555-40-17	52555-40-18	52555-40-10	52555-40-03	52555-40-04
			INSULATED & CARBON FIBER HANDLES				NON-INSULATED HANDLES	
 ALLIS GRASPER, SHORT VERSION, SA 15MM TIP	5MM	24CM	52224-18B1	52224-18B17	52224-18B18	52224-18B10	52224-18B3	52224-18B4
	5MM	33CM	52255-18B1	52255-18B17	52255-18B18	52255-18B10	52255-18B3	52255-18B4
	5MM	36CM	52236-18B1	52236-18B17	52236-18B18	52236-18B10	52236-18B3	52236-18B4
	5MM	45CM	52155-18B1	52155-18B17	52155-18B18	52155-18B10	52155-18B3	52155-18B4
 ALLIS, SHORT VERSION, 3 X 4 TEETH, SERRATED 12MM TIP	5MM	24CM	52224-19B1	52224-19B17	52224-19B18	52224-19B10	52224-19B3	52224-19B4
	5MM	33CM	52255-19B1	52255-19B17	52255-19B18	52255-19B10	52255-19B3	52255-19B4
	5MM	36CM	52236-19B1	52236-19B17	52236-19B18	52236-19B10	52236-19B3	52236-19B4
	5MM	45CM	52155-19B1	52155-19B17	52155-19B18	52155-19B10	52155-19B3	52155-19B4
 ALLIS, SHORT VERSION, DOUBLE ROW OF TEETH, SERRATED 12MM TIP	5MM	24CM	52224-119B1	52224-119B17	52224-119B18	52224-119B10	52224-119B3	52224-119B4
	5MM	33CM	52255-119B1	52255-119B17	52255-119B18	52255-119B10	52255-119B3	52255-119B4
	5MM	36CM	52236-119B1	52236-119B17	52236-119B18	52236-119B10	52236-119B3	52236-119B4
	5MM	45CM	52155-119B1	52155-119B17	52155-119B18	52155-119B10	52155-119B3	52155-119B4
 ALLIS, LONG VERSION, DOUBLE ROW OF TEETH, SERRATED 25MM TIP	5MM	24CM	52224-219B1	52224-219B17	52224-219B18	52224-219B10	52224-219B3	52224-219B4
	5MM	33CM	52255-219B1	52255-219B17	52255-219B18	52255-219B10	52255-219B3	52255-219B4
	5MM	36CM	52236-219B1	52236-219B17	52236-219B18	52236-219B10	52236-219B3	52236-219B4
	5MM	45CM	52155-219B1	52155-219B17	52155-219B18	52155-219B10	52155-219B3	52155-219B4
 ALLIS GRASPER, MEDIUM, WECK STYLE 20MM TIP	5MM	24CM	52224-20B1	52224-20B17	52224-20B18	52224-20B10	52224-20B3	52224-20B4
	5MM	33CM	52255-20B1	52255-20B17	52255-20B18	52255-20B10	52255-20B3	52255-20B4
	5MM	36CM	52236-20B1	52236-20B17	52236-20B18	52236-20B10	52236-20B3	52236-20B4
	5MM	45CM	52155-20B1	52155-20B17	52155-20B18	52155-20B10	52155-20B3	52155-20B4
 ALLIS GRASPER, STANDARD VERSION 30MM TIP	5MM	24CM	52224-21B1	52224-21B17	52224-21B18	52224-21B10	52224-21B3	52224-21B4
	5MM	33CM	52255-21B1	52255-21B17	52255-21B18	52255-21B10	52255-21B3	52255-21B4
	5MM	36CM	52236-21B1	52236-21B17	52236-21B18	52236-21B10	52236-21B3	52236-21B4
	5MM	45CM	52155-21B1	52155-21B17	52155-21B18	52155-21B10	52155-21B3	52155-21B4
	10MM	33CM	52102-21B1	52102-21B17	52102-21B18	52102-21B10	52102-21B3	52102-21B4
	10MM	36CM	52103-21B1	52103-21B17	52103-21B18	52103-21B10	52103-21B3	52103-21B4
	10MM	45CM	52101-21B1	52101-21B17	52101-21B18	52101-21B10	52101-21B3	52101-21B4









STYLE B:

ROTATABLE, ONE-PIECE INSTRUMENT WITH FLUSH PORT



Dissectors & Graspers

TIP ID.	DIAMETER	LENGTH	52555-40-01	52555-40-17	52555-40-18	52555-40-10	52555-40-03	52555-40-04
			INSULATED & CARBON FIBER HANDLES				NON-INSULATED HANDLES	
 ALLIS GRASPER, TC, STANDARD VERSION 35MM TIP	5MM	24CM	52224-57B1	52224-57B17	52224-57B18	52224-57B10	52224-57B3	52224-57B4
	5MM	33CM	52255-57B1	52255-57B17	52255-57B18	52255-57B10	52255-57B3	52255-57B4
	5MM	36CM	52236-57B1	52236-57B17	52236-57B18	52236-57B10	52236-57B3	52236-57B4
	5MM	45CM	52155-57B1	52155-57B17	52155-57B18	52155-57B10	52155-57B3	52155-57B4
 DEBAKEY GRASPER, 20MM JAW 20MM TIP	5MM	24CM	52224-22B1	52224-22B17	52224-22B18	52224-22B10	52224-22B3	52224-22B4
	5MM	33CM	52255-22B1	52255-22B17	52255-22B18	52255-22B10	52255-22B3	52255-22B4
	5MM	36CM	52236-22B1	52236-22B17	52236-22B18	52236-22B10	52236-22B3	52236-22B4
	5MM	45CM	52155-22B1	52155-22B17	52155-22B18	52155-22B10	52155-22B3	52155-22B4
 DEBAKEY GRASPER, 40MM JAW 40MM TIP	5MM	24CM	52224-23B1	52224-23B17	52224-23B18	52224-23B10	52224-23B3	52224-23B4
	5MM	33CM	52255-23B1	52255-23B17	52255-23B18	52255-23B10	52255-23B3	52255-23B4
	5MM	36CM	52236-23B1	52236-23B17	52236-23B18	52236-23B10	52236-23B3	52236-23B4
	5MM	45CM	52155-23B1	52155-23B17	52155-23B18	52155-23B10	52155-23B3	52155-23B4
	10MM	33CM	52102-22B1	52102-22B17	52102-22B18	52102-22B10	52102-22B3	52102-22B4
	10MM	36CM	52103-22B1	52103-22B17	52103-22B18	52103-22B10	52103-22B3	52103-22B4
 DEBAKEY GRASPER, 60MM JAW 60MM TIP	5MM	24CM	52224-160B1	52224-160B17	52224-160B18	52224-160B10	52224-160B3	52224-160B4
	5MM	33CM	52255-160B1	52255-160B17	52255-160B18	52255-160B10	52255-160B3	52255-160B4
	5MM	36CM	52236-160B1	52236-160B17	52236-160B18	52236-160B10	52236-160B3	52236-160B4
	5MM	45CM	52155-160B1	52155-160B17	52155-160B18	52155-160B10	52155-160B3	52155-160B4
	10MM	33CM	52102-23B1	52102-23B17	52102-23B18	52102-23B10	52102-23B3	52102-23B4
	10MM	36CM	52103-23B1	52103-23B17	52103-23B18	52103-23B10	52103-23B3	52103-23B4
 HUNTER DEBAKEY, FENESTRATED, 20MM 20MM TIP	5MM	24CM	52224-58B1	52224-58B17	52224-58B18	52224-58B10	52224-58B3	52224-58B4
	5MM	33CM	52255-58B1	52255-58B17	52255-58B18	52255-58B10	52255-58B3	52255-58B4
	5MM	36CM	52236-58B1	52236-58B17	52236-58B18	52236-58B10	52236-58B3	52236-58B4
	5MM	45CM	52155-58B1	52155-58B17	52155-58B18	52155-58B10	52155-58B3	52155-58B4
 HUNTER DEBAKEY, FENESTRATED, 40MM 40MM TIP	5MM	24CM	52224-159B1	52224-159B17	52224-159B18	52224-159B10	52224-159B3	52224-159B4
	5MM	33CM	52255-159B1	52255-159B17	52255-159B18	52255-159B10	52255-159B3	52255-159B4
	5MM	36CM	52236-159B1	52236-159B17	52236-159B18	52236-159B10	52236-159B3	52236-159B4
	5MM	45CM	52155-159B1	52155-159B17	52155-159B18	52155-159B10	52155-159B3	52155-159B4



STYLE B:

ROTATABLE, ONE-PIECE INSTRUMENT WITH FLUSH PORT



Dissectors & Graspers

TIP ID.	DIAMETER	LENGTH	52555-40-01	52555-40-17	52555-40-18	52555-40-10	52555-40-03	52555-40-04
INSULATED & CARBON FIBER HANDLES						NON-INSULATED HANDLES		
HUNTER DEBAKEY, FENESTRATED, 60MM 60MM TIP	5MM	24CM	52224-160B1	52224-160B17	52224-160B18	52224-160B10	52224-160B3	52224-160B4
	5MM	33CM	52255-160B1	52255-160B17	52255-160B18	52255-160B10	52255-160B3	52255-160B4
	5MM	36CM	52236-160B1	52236-160B17	52236-160B18	52236-160B10	52236-160B3	52236-160B4
	5MM	45CM	52155-160B1	52155-160B17	52155-160B18	52155-160B10	52155-160B3	52155-160B4
DEBAKEY GRASPER, CURVED 30MM TIP	5MM	24CM	52224-46B1	52224-46B17	52224-46B18	52224-46B10	52224-46B3	52224-46B4
	5MM	33CM	52255-46B1	52255-46B17	52255-46B18	52255-46B10	52255-46B3	52255-46B4
	5MM	36CM	52236-46B1	52236-46B17	52236-46B18	52236-46B10	52236-46B3	52236-46B4
	5MM	45CM	52155-46B1	52155-46B17	52155-46B18	52155-46B10	52155-46B3	52155-46B4
DEBAKEY MARYLAND GRASPER 35MM TIP	5MM	24CM	52224-149B1	52224-149B17	52224-149B18	52224-149B10	52224-149B3	52224-149B4
	5MM	33CM	52255-149B1	52255-149B17	52255-149B18	52255-149B10	52255-149B3	52255-149B4
	5MM	36CM	52236-149B1	52236-149B17	52236-149B18	52236-149B10	52236-149B3	52236-149B4
	5MM	45CM	52155-149B1	52155-149B17	52155-149B18	52155-149B10	52155-149B3	52155-149B4
GLASSMAN ATRAUMATIC GRASPER 30MM TIP	5MM	24CM	52224-24B1	52224-24B17	52224-24B18	52224-24B10	52224-24B3	52224-24B4
	5MM	33CM	52255-24B1	52255-24B17	52255-24B18	52255-24B10	52255-24B3	52255-24B4
	5MM	36CM	52236-24B1	52236-24B17	52236-24B18	52236-24B10	52236-24B3	52236-24B4
	5MM	45CM	52155-24B1	52155-24B17	52155-24B18	52155-24B10	52155-24B3	52155-24B4
GRASPER, CROSS SERRATED, SINGLE ACTION 10MM TIP	5MM	24CM	52224-25B1	52224-25B17	52224-25B18	52224-25B10	52224-25B3	52224-25B4
	5MM	33CM	52255-25B1	52255-25B17	52255-25B18	52255-25B10	52255-25B3	52255-25B4
	5MM	36CM	52236-25B1	52236-25B17	52236-25B18	52236-25B10	52236-25B3	52236-25B4
	5MM	45CM	52155-25B1	52155-25B17	52155-25B18	52155-25B10	52155-25B3	52155-25B4
DOUBLE CUP FUNDUS MAXI GRASPER 16MM TIP	5MM	24CM	52224-26B1	52224-26B17	52224-26B18	52224-26B10	52224-26B3	52224-26B4
	5MM	33CM	52255-26B1	52255-26B17	52255-26B18	52255-26B10	52255-26B3	52255-26B4
	5MM	36CM	52236-26B1	52236-26B17	52236-26B18	52236-26B10	52236-26B3	52236-26B4
	5MM	45CM	52155-26B1	52155-26B17	52155-26B18	52155-26B10	52155-26B3	52155-26B4







STYLE B:

ROTATABLE, ONE-PIECE INSTRUMENT WITH FLUSH PORT

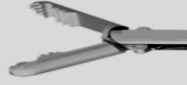

Dissectors & Graspers

TIP ID.	DIAMETER	LENGTH	52555-40-01	52555-40-17	52555-40-18	52555-40-10	52555-40-03	52555-40-04
			INSULATED & CARBON FIBER HANDLES				NON-INSULATED HANDLES	
"WINER" STYLE FUNDUS GRASPER  16MM TIP	5MM	24CM	52224-326B1	52224-326B17	52224-326B18	52224-326B10	52224-326B3	52224-326B4
	5MM	33CM	52255-326B1	52255-326B17	52255-326B18	52255-326B10	52255-326B3	52255-326B4
	5MM	36CM	52236-326B1	52236-326B17	52236-326B18	52236-326B10	52236-326B3	52236-326B4
	5MM	45CM	52155-326B1	52155-326B17	52155-326B18	52155-326B10	52155-326B3	52155-326B4
"MCKEARNAN" STYLE FUNDUS GRASPER  16MM TIP	5MM	24CM	52224-126B1	52224-126B17	52224-126B18	52224-126B10	52224-126B3	52224-126B4
	5MM	33CM	52255-126B1	52255-126B17	52255-126B18	52255-126B10	52255-126B3	52255-126B4
	5MM	36CM	52236-126B1	52236-126B17	52236-126B18	52236-126B10	52236-126B3	52236-126B4
	5MM	45CM	52155-126B1	52155-126B17	52155-126B18	52155-126B10	52155-126B3	52155-126B4
FENESTRATED DOUBLE FUNDUS GRASPER  16MM TIP	5MM	24CM	52224-226B1	52224-226B17	52224-226B18	52224-226B10	52224-226B3	52224-226B4
	5MM	33CM	52255-226B1	52255-226B17	52255-226B18	52255-226B10	52255-226B3	52255-226B4
	5MM	36CM	52236-226B1	52236-226B17	52236-226B18	52236-226B10	52236-226B3	52236-226B4
	5MM	45CM	52155-226B1	52155-226B17	52155-226B18	52155-226B10	52155-226B3	52155-226B4
"JARIT STYLE" GRASPING FORCEPS DUAL CUP  16MM TIP	5MM	24CM	52224-426A1	52224-426A17	52224-426A18	52224-426A10	52224-426A3	52224-426A4
	5MM	33CM	52255-426A1	52255-426A17	52255-426A18	52255-426A10	52255-426A3	52255-426A4
	5MM	36CM	52236-426A1	52236-426A17	52236-426A18	52236-426A10	52236-426A3	52236-426A4
	5MM	45CM	52155-426A1	52155-426A17	52155-426A18	52155-426A10	52155-426A3	52155-426A4
ENDOCLINCH FENESTRATED GRASPER  20MM TIP	5MM	24CM	52224-27B1	52224-27B17	52224-27B18	52224-27B10	52224-27B3	52224-27B4
	5MM	33CM	52255-27B1	52255-27B17	52255-27B18	52255-27B10	52255-27B3	52255-27B4
	5MM	36CM	52236-27B1	52236-27B17	52236-27B18	52236-27B10	52236-27B3	52236-27B4
	5MM	45CM	52155-27B1	52155-27B17	52155-27B18	52155-27B10	52155-27B3	52155-27B4
RETRO-FACING, RAT TOOTH W/ CUP  10MM TIP	5MM	24CM	52224-28B1	52224-28B17	52224-28B18	52224-28B10	52224-28B3	52224-28B4
	5MM	33CM	52255-28B1	52255-28B17	52255-28B18	52255-28B10	52255-28B3	52255-28B4
	5MM	36CM	52236-28B1	52236-28B17	52236-28B18	52236-28B10	52236-28B3	52236-28B4
	5MM	45CM	52155-28B1	52155-28B17	52155-28B18	52155-28B10	52155-28B3	52155-28B4







STYLE B:

ROTATABLE, ONE-PIECE INSTRUMENT WITH FLUSH PORT

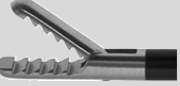
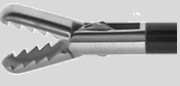

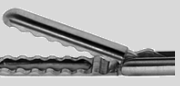
Dissectors & Graspers





TIP ID.	DIAMETER	LENGTH	52555-40-01	52555-40-17	52555-40-18	52555-40-10	52555-40-03	52555-40-04
			INSULATED & CARBON FIBER HANDLES				NON-INSULATED HANDLES	
 ALLIGATOR GRASPER, RETRO-FACING TEETH, 10MM TIP	5MM	24CM	52224-29B1	52224-29B17	52224-29B18	52224-29B10	52224-29B3	52224-29B4
	5MM	33CM	52255-29B1	52255-29B17	52255-29B18	52255-29B10	52255-29B3	52255-29B4
	5MM	36CM	52236-29B1	52236-29B17	52236-29B18	52236-29B10	52236-29B3	52236-29B4
	5MM	45CM	52155-29B1	52155-29B17	52155-29B18	52155-29B10	52155-29B3	52155-29B4
 ALLIGATOR GRASPER, RETRO-FACING TEETH, SINGLE ACTION, 15MM JAW	5MM	24CM	52224-30B1	52224-30B17	52224-30B18	52224-30B10	52224-30B3	52224-30B4
	5MM	33CM	52255-30B1	52255-30B17	52255-30B18	52255-30B10	52255-30B3	52255-30B4
	5MM	36CM	52236-30B1	52236-30B17	52236-30B18	52236-30B10	52236-30B3	52236-30B4
	5MM	45CM	52155-30B1	52155-30B17	52155-30B18	52155-30B10	52155-30B3	52155-30B4
 CUP SHAPED GRASPER, W/ RETRO-FACING TEETH, 10MM JAW	5MM	24CM	52224-31B1	52224-31B17	52224-31B18	52224-31B10	52224-31B3	52224-31B4
	5MM	33CM	52255-31B1	52255-31B17	52255-31B18	52255-31B10	52255-31B3	52255-31B4
	5MM	36CM	52236-31B1	52236-31B17	52236-31B18	52236-31B10	52236-31B3	52236-31B4
	5MM	45CM	52155-31B1	52155-31B17	52155-31B18	52155-31B10	52155-31B3	52155-31B4
 WAVE GRASPER, LONG BEVELED EDGE, DOUBLE ACTION, 22MM JAW	5MM	24CM	52224-32B1	52224-32B17	52224-32B18	52224-32B10	52224-32B3	52224-32B4
	5MM	33CM	52255-32B1	52255-32B17	52255-32B18	52255-32B10	52255-32B3	52255-32B4
	5MM	36CM	52236-32B1	52236-32B17	52236-32B18	52236-32B10	52236-32B3	52236-32B4
	5MM	45CM	52155-32B1	52155-32B17	52155-32B18	52155-32B10	52155-32B3	52155-32B4
 WAVE GRASPER, LONG BEVELED EDGE, SINGLE ACTION, 22MM JAW	5MM	24CM	52224-33B1	52224-33B17	52224-33B18	52224-33B10	52224-33B3	52224-33B4
	5MM	33CM	52255-33B1	52255-33B17	52255-33B18	52255-33B10	52255-33B3	52255-33B4
	5MM	36CM	52236-33B1	52236-33B17	52236-33B18	52236-33B10	52236-33B3	52236-33B4
	5MM	45CM	52155-33B1	52155-33B17	52155-33B18	52155-33B10	52155-33B3	52155-33B4
 CLAW GRASPER, 2 X 3 TEETH, SINGLE ACTION, 20MM JAW	5MM	24CM	52224-36B1	52224-36B17	52224-36B18	52224-36B10	52224-36B3	52224-36B4
	5MM	33CM	52255-36B1	52255-36B17	52255-36B18	52255-36B10	52255-36B3	52255-36B4
	5MM	36CM	52236-36B1	52236-36B17	52236-36B18	52236-36B10	52236-36B3	52236-36B4
	5MM	45CM	52155-36B1	52155-36B17	52155-36B18	52155-36B10	52155-36B3	52155-36B4
	10MM	33CM	52102-36B1	52102-36B17	52102-36B18	52102-36B10	52102-36B3	52102-36B4
	10MM	36CM	52103-36B1	52103-36B17	52103-36B18	52103-36B10	52103-36B3	52103-36B4
	10MM	45CM	52101-36B1	52101-36B17	52101-36B18	52101-36B10	52101-36B3	52101-36B4

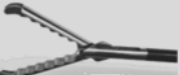

STYLE B:

ROTATABLE, ONE-PIECE INSTRUMENT WITH FLUSH PORT

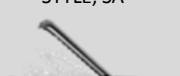
Dissectors & Graspers

TIP ID.	DIAMETER	LENGTH	52555-40-01	52555-40-17	52555-40-18	52555-40-10	52555-40-03	52555-40-04
			INSULATED & CARBON FIBER HANDLES				NON-INSULATED HANDLES	
CLAW GRASPER, 2 X 3 TEETH, W/ XTRA ROW OF TEETH  20MM JAW	5MM	24CM	52224-136B1	52224-136B17	52224-136B18	52224-136B10	52224-136B3	52224-136B4
	5MM	33CM	52255-136B1	52255-136B17	52255-136B18	52255-136B10	52255-136B3	52255-136B4
	5MM	36CM	52236-136B1	52236-136B17	52236-136B18	52236-136B10	52236-136B3	52236-136B4
	5MM	45CM	52155-136B1	52155-136B17	52155-136B18	52155-136B10	52155-136B3	52155-136B4
RETRACTION GRASPER, 2 X 3 TEETH, COBRA STYLE, DA  20MM JAW	5MM	24CM	52224-34B1	52224-34B17	52224-34B18	52224-34B10	52224-34B3	52224-34B4
	5MM	33CM	52255-34B1	52255-34B17	52255-34B18	52255-34B10	52255-34B3	52255-34B4
	5MM	36CM	52236-34B1	52236-34B17	52236-34B18	52236-34B10	52236-34B3	52236-34B4
	5MM	45CM	52155-34B1	52155-34B17	52155-34B18	52155-34B10	52155-34B3	52155-34B4
RETRACTION GRASPER, 2 X 3 TEETH, COBRA STYLE, SA  20MM JAW	5MM	24CM	52224-35B1	52224-35B17	52224-35B18	52224-35B10	52224-35B3	52224-35B4
	5MM	33CM	52255-35B1	52255-35B17	52255-35B18	52255-35B10	52255-35B3	52255-35B4
	5MM	36CM	52236-35B1	52236-35B17	52236-35B18	52236-35B10	52236-35B3	52236-35B4
	5MM	45CM	52155-35B1	52155-35B17	52155-35B18	52155-35B10	52155-35B3	52155-35B4
RETRACTION GRASPER, 2 X 3 TEETH, JARIT STYLE, DA  20MM JAW	5MM	24CM	52224-134B1	52224-134B17	52224-134B18	52224-134B10	52224-134B3	52224-134B4
	5MM	33CM	52255-134B1	52255-134B17	52255-134B18	52255-134B10	52255-134B3	52255-134B4
	5MM	36CM	52236-134B1	52236-134B17	52236-134B18	52236-134B10	52236-134B3	52236-134B4
	5MM	45CM	52155-134B1	52155-134B17	52155-134B18	52155-134B10	52155-134B3	52155-134B4
RETRACTION GRASPER, 2 X 3 TEETH, JARIT STYLE, SA  20MM JAW	5MM	24CM	52224-135B1	52224-135B17	52224-135B18	52224-135B10	52224-135B3	52224-135B4
	5MM	33CM	52255-135B1	52255-135B17	52255-135B18	52255-135B10	52255-135B3	52255-135B4
	5MM	36CM	52236-135B1	52236-135B17	52236-135B18	52236-135B10	52236-135B3	52236-135B4
	5MM	45CM	52155-135B1	52155-135B17	52155-135B18	52155-135B10	52155-135B3	52155-135B4
ATRUAMATIC FENESTRATED GRASPER, CURVED  16MM JAW	5MM	24CM	52224-37B1	52224-37B17	52224-37B18	52224-37B10	52224-37B3	52224-37B4
	5MM	33CM	52255-37B1	52255-37B17	52255-37B18	52255-37B10	52255-37B3	52255-37B4
	5MM	36CM	52236-37B1	52236-37B17	52236-37B18	52236-37B10	52236-37B3	52236-37B4
	5MM	45CM	52155-37B1	52155-37B17	52155-37B18	52155-37B10	52155-37B3	52155-37B4









STYLE B:

ROTATABLE, ONE-PIECE INSTRUMENT WITH FLUSH PORT



Dissectors & Graspers

TIP ID.	DIAMETER	LENGTH	52555-40-01	52555-40-17	52555-40-18	52555-40-10	52555-40-03	52555-40-04
			INSULATED & CARBON FIBER HANDLES				NON-INSULATED HANDLES	
FENESTRATED GRASPER, 16MM JAW  16MM JAW	5MM	24CM	52224-38B1	52224-38B17	52224-38B18	52224-38B10	52224-38B3	52224-38B4
	5MM	33CM	52255-38B1	52255-38B17	52255-38B18	52255-38B10	52255-38B3	52255-38B4
	5MM	36CM	52236-38B1	52236-38B17	52236-38B18	52236-38B10	52236-38B3	52236-38B4
	5MM	45CM	52155-38B1	52155-38B17	52155-38B18	52155-38B10	52155-38B3	52155-38B4
FENESTRATED GRASPER, 22MM JAW  22MM JAW	5MM	24CM	52224-39B1	52224-39B17	52224-39B18	52224-39B10	52224-39B3	52224-39B4
	5MM	33CM	52255-39B1	52255-39B17	52255-39B18	52255-39B10	52255-39B3	52255-39B4
	5MM	36CM	52236-39B1	52236-39B17	52236-39B18	52236-39B10	52236-39B3	52236-39B4
	5MM	45CM	52155-39B1	52155-39B17	52155-39B18	52155-39B10	52155-39B3	52155-39B4
FENESTRATED GRASPER, 40MM JAW  40MM JAW	5MM	24CM	52224-40B1	52224-40B17	52224-40B18	52224-40B10	52224-40B3	52224-40B4
	5MM	33CM	52255-40B1	52255-40B17	52255-40B18	52255-40B10	52255-40B3	52255-40B4
	5MM	36CM	52236-40B1	52236-40B17	52236-40B18	52236-40B10	52236-40B3	52236-40B4
	5MM	45CM	52155-40B1	52155-40B17	52155-40B18	52155-40B10	52155-40B3	52155-40B4
JOHAN FENESTRATED GRASPER, 20MM TIP, SINGLE ACTION  20MM JAW	5MM	24CM	52224-41B1	52224-41B17	52224-41B18	52224-41B10	52224-41B3	52224-41B4
	5MM	33CM	52255-41B1	52255-41B17	52255-41B18	52255-41B10	52255-41B3	52255-41B4
	5MM	36CM	52236-41B1	52236-41B17	52236-41B18	52236-41B10	52236-41B3	52236-41B4
	5MM	45CM	52155-41B1	52155-41B17	52155-41B18	52155-41B10	52155-41B3	52155-41B4
JOHAN FENESTRATED GRASPER, 45MM TIP, SINGLE ACTION  45MM JAW	5MM	24CM	52224-42B1	52224-42B17	52224-42B18	52224-42B10	52224-42B3	52224-42B4
	5MM	33CM	52255-42B1	52255-42B17	52255-42B18	52255-42B10	52255-42B3	52255-42B4
	5MM	36CM	52236-42B1	52236-42B17	52236-42B18	52236-42B10	52236-42B3	52236-42B4
	5MM	45CM	52155-42B1	52155-42B17	52155-42B18	52155-42B10	52155-42B3	52155-42B4
DOUBLE FENESTRATED GRASPER, 25MM JAW  25MM JAW	5MM	24CM	52224-139B1	52224-139B17	52224-139B18	52224-139B10	52224-139B3	52224-139B4
	5MM	33CM	52255-139B1	52255-139B17	52255-139B18	52255-139B10	52255-139B3	52255-139B4
	5MM	36CM	52236-139B1	52236-139B17	52236-139B18	52236-139B10	52236-139B3	52236-139B4
	5MM	45CM	52155-139B1	52155-139B17	52155-139B18	52155-139B10	52155-139B3	52155-139B4







STYLE B:

ROTATABLE, ONE-PIECE INSTRUMENT WITH FLUSH PORT

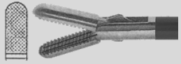
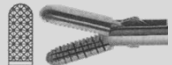

Dissectors & Graspers

TIP ID.	DIAMETER	LENGTH	52555-40-01	52555-40-17	52555-40-18	52555-40-10	52555-40-03	52555-40-04
			INSULATED & CARBON FIBER HANDLES				NON-INSULATED HANDLES	
BLUNT ATRAUMATIC GRASPER W/ CROSS-SERRATED TIPS, DBL-ACTION  14MM JAW	5MM	24CM	52224-56B1	52224-56B17	52224-56B18	52224-56B10	52224-56B3	52224-56B4
	5MM	33CM	52255-56B1	52255-56B17	52255-56B18	52255-56B10	52255-56B3	52255-56B4
	5MM	36CM	52236-56B1	52236-56B17	52236-56B18	52236-56B10	52236-56B3	52236-56B4
	5MM	45CM	52155-56B1	52155-56B17	52155-56B18	52155-56B10	52155-56B3	52155-56B4
BULLET NOSE GRASPER TC, MICRO DIAMOND JAW PATTERN  15MM JAW	5MM	24CM	52224-48B1	52224-48B17	52224-48B18	52224-48B10	52224-48B3	52224-48B4
	5MM	33CM	52255-48B1	52255-48B17	52255-48B18	52255-48B10	52255-48B3	52255-48B4
	5MM	36CM	52236-48B1	52236-48B17	52236-48B18	52236-48B10	52236-48B3	52236-48B4
	5MM	45CM	52155-48B1	52155-48B17	52155-48B18	52155-48B10	52155-48B3	52155-48B4
BULLET NOSE GRASPER, TC, CROSS DIAMOND JAW PATTERN  15MM JAW	5MM	24CM	52224-49B1	52224-49B17	52224-49B18	52224-49B10	52224-49B3	52224-49B4
	5MM	33CM	52255-49B1	52255-49B17	52255-49B18	52255-49B10	52255-49B3	52255-49B4
	5MM	36CM	52236-49B1	52236-49B17	52236-49B18	52236-49B10	52236-49B3	52236-49B4
	5MM	45CM	52155-49B1	52155-49B17	52155-49B18	52155-49B10	52155-49B3	52155-49B4
LONG TAPERED GRASPER W/ ATRAUMATIC TEETH  20MM JAW	5MM	24CM	52224-51B1	52224-51B17	52224-51B18	52224-51B10	52224-51B3	52224-51B4
	5MM	33CM	52255-51B1	52255-51B17	52255-51B18	52255-51B10	52255-51B3	52255-51B4
	5MM	36CM	52236-51B1	52236-51B17	52236-51B18	52236-51B10	52236-51B3	52236-51B4
	5MM	45CM	52155-51B1	52155-51B17	52155-51B18	52155-51B10	52155-51B3	52155-51B4
WAVE GRASPER, POINTED, SINGLE-ACTION  14MM JAW	5MM	24CM	52224-54B1	52224-54B17	52224-54B18	52224-54B10	52224-54B3	52224-54B4
	5MM	33CM	52255-54B1	52255-54B17	52255-54B18	52255-54B10	52255-54B3	52255-54B4
	5MM	36CM	52236-54B1	52236-54B17	52236-54B18	52236-54B10	52236-54B3	52236-54B4
	5MM	45CM	52155-54B1	52155-54B17	52155-54B18	52155-54B10	52155-54B3	52155-54B4
"DAVOL" TYPE, GRASPER, SCOOPED-OUT JAW & GENTLY MASHING TEETH  15MM JAW	5MM	24CM	52224-90B1	52224-90B17	52224-90B18	52224-90B10	52224-90B3	52224-90B4
	5MM	33CM	52255-90B1	52255-90B17	52255-90B18	52255-90B10	52255-90B3	52255-90B4
	5MM	36CM	52236-90B1	52236-90B17	52236-90B18	52236-90B10	52236-90B3	52236-90B4
	5MM	45CM	52155-90B1	52155-90B17	52155-90B18	52155-90B10	52155-90B3	52155-90B4









STYLE B:

ROTATABLE, ONE-PIECE INSTRUMENT WITH FLUSH PORT



Dissectors & Graspers







TIP ID.	DIAMETER	LENGTH	52555-40-01	52555-40-17	52555-40-18	52555-40-10	52555-40-03	52555-40-04
			INSULATED & CARBON FIBER HANDLES				NON-INSULATED HANDLES	
 STRONG ATRAUMATIC CLAMP, 40MM STRAIGHT JAW 40MM JAW	10MM	33CM	52102-46B1	52102-46B17	52102-46B18	52102-46B10	52102-46B3	52102-46B4
	10MM	36CM	52103-46B1	52103-46B17	52103-46B18	52103-46B10	52103-46B3	52103-46B4
	10MM	45CM	52101-46B1	52101-46B17	52101-46B18	52101-46B10	52101-46B3	52101-46B4
 STRONG ATRAUMATIC CLAMP, 40MM CURVED JAW 40MM JAW	10MM	33CM	52102-47B1	52102-47B17	52102-47B18	52102-47B10	52102-47B3	52102-47B4
	10MM	36CM	52103-47B1	52103-47B17	52103-47B18	52103-47B10	52103-47B3	52103-47B4
	10MM	45CM	52101-47B1	52101-47B17	52101-47B18	52101-47B10	52101-47B3	52101-47B4
 ANVIL GRASPER TO GRASP & HOLD ANVIL OF CIRCULAR STAPLER	10MM	33CM	52102-20B1	52102-20B17	52102-20B18	52102-20B10	52102-20B3	52102-20B4
	10MM	36CM	52103-20B1	52103-20B17	52103-20B18	52103-20B10	52103-20B3	52103-20B4
	10MM	45CM	52101-20B1	52101-20B17	52101-20B18	52101-20B10	52101-20B3	52101-20B4
 ALLIGATOR GRASPER, RETRO-FACING TEETH, 15MM JAW	5MM	24CM	52224-129B1	52224-129B17	52224-129B18	52224-129B10	52224-129B3	52224-129B4
	5MM	33CM	52255-129B1	52255-129B17	52255-129B18	52255-129B10	52255-129B3	52255-129B4
	5MM	36CM	52236-129B1	52236-129B17	52236-129B18	52236-129B10	52236-129B3	52236-129B4
	5MM	45CM	52155-129B1	52155-129B17	52155-129B18	52155-129B10	52155-129B3	52155-129B4
 DEBAKEY GRASPER, 34MM JAW 34MM TIP	5MM	24CM	52224-122B1	52224-122B17	52224-122B18	52224-122B10	52224-122B3	52224-122B4
	5MM	33CM	52255-122B1	52255-122B17	52255-122B18	52255-122B10	52255-122B3	52255-122B4
	5MM	36CM	52236-122B1	52236-122B17	52236-122B18	52236-122B10	52236-122B3	52236-122B4
	5MM	45CM	52155-122B1	52155-122B17	52155-122B18	52155-122B10	52155-122B3	52155-122B4
 PADDLE BABCOCK GRASPER 30MM TIP	5MM	24CM	52224-216B1	52224-216B17	52224-216B18	52224-216B10	52224-216B3	52224-216B4
	5MM	33CM	52255-216B1	52255-216B17	52255-216B18	52255-216B10	52255-216B3	52255-216B4
	5MM	36CM	52236-216B1	52236-216B17	52236-216B18	52236-216B10	52236-216B3	52236-216B4
	5MM	45CM	52155-216B1	52155-216B17	52155-216B18	52155-216B10	52155-216B3	52155-216B4



STYLE B:

ROTATABLE, ONE-PIECE INSTRUMENT WITH FLUSH PORT

Forceps & Scissors

TIP ID.	DIAMETER	LENGTH	52555-40-01	52555-40-17	52555-40-18	52555-40-10	52555-40-03	52555-40-15
			INSULATED & CARBON FIBER HANDLES				NON-INSULATED HANDLES	
 HOOK SCISSORS, SINGLE-ACTION 10MM TIP	5MM	24CM	52224-60B1	52224-60B17	52224-60B18	52224-60B10	52224-60B3	52224-60B15
	5MM	33CM	52255-60B1	52255-60B17	52255-60B18	52255-60B10	52255-60B3	52255-60B15
	5MM	36CM	52236-60B1	52236-60B17	52236-60B18	52236-60B10	52236-60B3	52236-60B15
	5MM	45CM	52155-60B1	52155-60B17	52155-60B18	52155-60B10	52155-60B3	52155-60B15
 MICRO TIP SCISSORS, STRAIGHT, SINGLE-ACTION 5MM TIP	5MM	24CM	52224-61B1	52224-61B17	52224-61B18	52224-61B10	52224-61B3	52224-61B15
	5MM	33CM	52255-61B1	52255-61B17	52255-61B18	52255-61B10	52255-61B3	52255-61B15
	5MM	36CM	52236-61B1	52236-61B17	52236-61B18	52236-61B10	52236-61B3	52236-61B15
	5MM	45CM	52155-61B1	52155-61B17	52155-61B18	52155-61B10	52155-61B3	52155-61B15
 MICRO TIP SCISSORS, CURVED, SINGLE-ACTION 5MM JAW	5MM	24CM	52224-62B1	52224-62B17	52224-62B18	52224-62B10	52224-62B3	52224-62B15
	5MM	33CM	52255-62B1	52255-62B17	52255-62B18	52255-62B10	52255-62B3	52255-62B15
	5MM	36CM	52236-62B1	52236-62B17	52236-62B18	52236-62B10	52236-62B3	52236-62B15
	5MM	45CM	52155-62B1	52155-62B17	52155-62B18	52155-62B10	52155-62B3	52155-62B15
 METZENBAUM SCISSORS, STRAIGHT, LONG BLADE (20MM) 20MM JAW	5MM	24CM	52224-63B1	52224-63B17	52224-63B18	52224-63B10	52224-63B3	52224-63B15
	5MM	33CM	52255-63B1	52255-63B17	52255-63B18	52255-63B10	52255-63B3	52255-63B15
	5MM	36CM	52236-63B1	52236-63B17	52236-63B18	52236-63B10	52236-63B3	52236-63B15
	5MM	45CM	52155-63B1	52155-63B17	52155-63B18	52155-63B10	52155-63B3	52155-63B15
 METZENBAUM SCISSORS, STRAIGHT, SHORT BLADE (12MM) 12MM JAW	5MM	24CM	52224-64B1	52224-64B17	52224-64B18	52224-64B10	52224-64B3	52224-64B15
	5MM	33CM	52255-64B1	52255-64B17	52255-64B18	52255-64B10	52255-64B3	52255-64B15
	5MM	36CM	52236-64B1	52236-64B17	52236-64B18	52236-64B10	52236-64B3	52236-64B15
	5MM	45CM	52155-64B1	52155-64B17	52155-64B18	52155-64B10	52155-64B3	52155-64B15
 METZENBAUM SCISSORS, CURVED, LONG BLADE (16MM) 16MM JAW	5MM	24CM	52224-65B1	52224-65B17	52224-65B18	52224-65B10	52224-65B3	52224-65B15
	5MM	33CM	52255-65B1	52255-65B17	52255-65B18	52255-65B10	52255-65B3	52255-65B15
	5MM	36CM	52236-65B1	52236-65B17	52236-65B18	52236-65B10	52236-65B3	52236-65B15
	5MM	45CM	52155-65B1	52155-65B17	52155-65B18	52155-65B10	52155-65B3	52155-65B15









STYLE B:

ROTATABLE, ONE-PIECE INSTRUMENT WITH FLUSH PORT



Forceps & Scissors

TIP ID.	DIAMETER	LENGTH	52555-40-01	52555-40-17	52555-40-18	52555-40-10	52555-40-03	52555-40-15
			INSULATED & CARBON FIBER HANDLES				NON-INSULATED HANDLES	
 METZENBAUM SCISSORS, HARDENED STEEL, CURVED BLADE (16MM TIP) 16MM JAW	5MM	24CM	52224-165B1	52224-165B17	52224-165B18	52224-165B10	52224-165B3	52224-165B15
	5MM	33CM	52255-165B1	52255-165B17	52255-165B18	52255-165B10	52255-165B3	52255-165B15
	5MM	36CM	52236-165B1	52236-165B17	52236-165B18	52236-165B10	52236-165B3	52236-165B15
	5MM	45CM	52155-165B1	52155-165B17	52155-165B18	52155-165B10	52155-165B3	52155-165B15
 METZENBAUM SCISSORS, WONDER-CUT , CURVED BLADE (20MM TIP) 20MM JAW	5MM	24CM	52224-265B1	52224-265B17	52224-265B18	52224-265B10	52224-265B3	52224-265B15
	5MM	33CM	52255-265B1	52255-265B17	52255-265B18	52255-265B10	52255-265B3	52255-265B15
	5MM	36CM	52236-265B1	52236-265B17	52236-265B18	52236-265B10	52236-265B3	52236-265B15
	5MM	45CM	52155-265B1	52155-265B17	52155-265B18	52155-265B10	52155-265B3	52155-265B15
 METZENBAUM SCISSORS, CURVED, SHORT BLADE (12MM) 12MM JAW	5MM	24CM	52224-166B1	52224-166B17	52224-166B18	52224-166B10	52224-166B3	52224-166B15
	5MM	33CM	52255-166B1	52255-166B17	52255-166B18	52255-166B10	52255-166B3	52255-166B15
	5MM	36CM	52236-166B1	52236-166B17	52236-166B18	52236-166B10	52236-166B3	52236-166B15
	5MM	45CM	52155-166B1	52155-166B17	52155-166B18	52155-166B10	52155-166B3	52155-166B15
 PERITONEAL SCISSORS, SINGLE-ACTION 15MM JAW	5MM	24CM	52224-67B1	52224-67B17	52224-67B18	52224-67B10	52224-67B3	52224-67B15
	5MM	33CM	52255-67B1	52255-67B17	52255-67B18	52255-67B10	52255-67B3	52255-67B15
	5MM	36CM	52236-67B1	52236-67B17	52236-67B18	52236-67B10	52236-67B3	52236-67B15
	5MM	45CM	52155-67B1	52155-67B17	52155-67B18	52155-67B10	52155-67B3	52155-67B15
 HOOK SCISSORS, TS, EXTRA HARD STEEL 10MM JAW	5MM	24CM	52224-76B1	52224-76B17	52224-76B18	52224-76B10	52224-76B3	52224-76B15
	5MM	33CM	52255-76B1	52255-76B17	52255-76B18	52255-76B10	52255-76B3	52255-76B15
	5MM	36CM	52236-76B1	52236-76B17	52236-76B18	52236-76B10	52236-76B3	52236-76B15
	5MM	45CM	52155-76B1	52155-76B17	52155-76B18	52155-76B10	52155-76B3	52155-76B15
 PERITONEAL SCISSORS, TS, EXTRA HARD STEEL, SINGLE-ACTION 15MM JAW	5MM	24CM	52224-77B1	52224-77B17	52224-77B18	52224-77B10	52224-77B3	52224-77B15
	5MM	33CM	52255-77B1	52255-77B17	52255-77B18	52255-77B10	52255-77B3	52255-77B15
	5MM	36CM	52236-77B1	52236-77B17	52236-77B18	52236-77B10	52236-77B3	52236-77B15
	5MM	45CM	52155-77B1	52155-77B17	52155-77B18	52155-77B10	52155-77B3	52155-77B15







STYLE B:

ROTATABLE, ONE-PIECE INSTRUMENT WITH FLUSH PORT

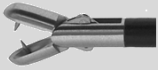

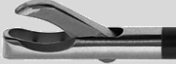
Forceps & Scissors

TIP ID.	DIAMETER	LENGTH	52555-40-01	52555-40-17	52555-40-18	52555-40-10	52555-40-03	52555-40-15
			INSULATED & CARBON FIBER HANDLES				NON-INSULATED HANDLES	
BIOPSY SPOON FORCEPS, DOUBLE- ACTION  10MM JAW	5MM	24CM	52224-70B1	52224-70B17	52224-70B18	52224-70B10	52224-70B3	52224-70B15
	5MM	33CM	52255-70B1	52255-70B17	52255-70B18	52255-70B10	52255-70B3	52255-70B15
	5MM	36CM	52236-70B1	52236-70B17	52236-70B18	52236-70B10	52236-70B3	52236-70B15
	5MM	45CM	52155-70B1	52155-70B17	52155-70B18	52155-70B10	52155-70B3	52155-70B15
BIOPSY SPOON FORCEPS, W/ TOOTH (SEMM-TYPE), DBL- ACTION  10MM JAW	5MM	24CM	52224-68B1	52224-68B17	52224-68B18	52224-68B10	52224-68B3	52224-68B15
	5MM	33CM	52255-68B1	52255-68B17	52255-68B18	52255-68B10	52255-68B3	52255-68B15
	5MM	36CM	52236-68B1	52236-68B17	52236-68B18	52236-68B10	52236-68B3	52236-68B15
	5MM	45CM	52155-68B1	52155-68B17	52155-68B18	52155-68B10	52155-68B3	52155-68B15
POINTED BIOPSY SPOON FORCEPS, SINGLE ACTION  10MM TIP	5MM	24CM	52224-305B1	52224-305B17	52224-305B18	52224-305B10	52224-305B3	52224-305B4
	5MM	33CM	52255-305B1	52255-305B17	52255-305B18	52255-305B10	52255-305B3	52255-305B4
	5MM	36CM	52236-305B1	52236-305B17	52236-305B18	52236-305B10	52236-305B3	52236-305B4
	5MM	45CM	52155-305B1	52155-305B17	52155-305B18	52155-305B10	52155-305B3	52155-305B4
BIOPSY PUNCH, SINGLE-ACTION  10MM TIP	5MM	24CM	52224-71B1	52224-71B17	52224-71B18	52224-71B10	52224-71B3	52224-71B15
	5MM	33CM	52255-71B1	52255-71B17	52255-71B18	52255-71B10	52255-71B3	52255-71B15
	5MM	36CM	52236-71B1	52236-71B17	52236-71B18	52236-71B10	52236-71B3	52236-71B15
	5MM	45CM	52155-71B1	52155-71B17	52155-71B18	52155-71B10	52155-71B3	52155-71B15
BIOPSY PUNCH WITH TOOTH, SINGLE- ACTION  10MM JAW	5MM	24CM	52224-72B1	52224-72B17	52224-72B18	52224-72B10	52224-72B3	52224-72B15
	5MM	33CM	52255-72B1	52255-72B17	52255-72B18	52255-72B10	52255-72B3	52255-72B15
	5MM	36CM	52236-72B1	52236-72B17	52236-72B18	52236-72B10	52236-72B3	52236-72B15
	5MM	45CM	52155-72B1	52155-72B17	52155-72B18	52155-72B10	52155-72B3	52155-72B15
BIOPSY PUNCH, SINGLE-ACTION  10MM JAW	5MM	24CM	52224-73B1	52224-73B17	52224-73B18	52224-73B10	52224-73B3	52224-73B15
	5MM	33CM	52255-73B1	52255-73B17	52255-73B18	52255-73B10	52255-73B3	52255-73B15
	5MM	36CM	52236-73B1	52236-73B17	52236-73B18	52236-73B10	52236-73B3	52236-73B15
	5MM	45CM	52155-73B1	52155-73B17	52155-73B18	52155-73B10	52155-73B3	52155-73B15



The *Summit Series* 5mm Modular, Three-Piece Detachable instruments is our most extensive line of Laparoscopic Instruments, offering over 2000 different combinations for the most precise instrumentation needed for any procedure. Our Three-Piece Modular Instruments are designed to come apart for superior cleaning. They are also completely interchangeable with any of our Laparoscopic Handles giving Hospitals & Surgery Centers the flexibility to quickly assemble instruments without having to match up every insert, shaft, & handle.

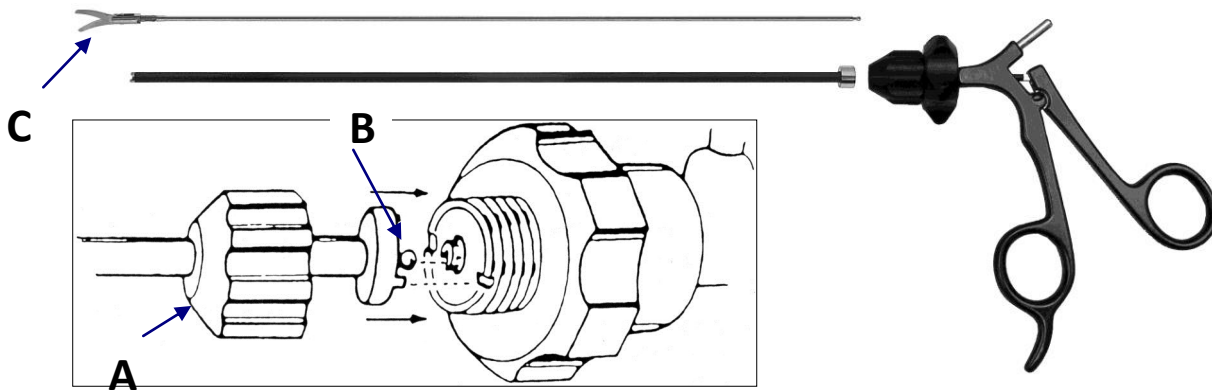

ASSEMBLY:

1. Turn the **Tip (C)** clockwise into the shaft
2. Set the handle in the open position & engage the **Ball (B) of Inner Rod** into its fixation in the handle port.
3. Turn main **Screw Cap (A)** clockwise until it engages the handle.



Summit Series Outer Tubes & Accessories



5MM INSULATED SHAFT

ITEM NO.	DESCRIPTION
52555-49	5MM X 24CM
52555-45	5MM X 33CM
52555-39	5MM X 36CM
52555-47	5MM X 45CM

5MM NON-INSULATED SHAFT

ITEM NO.	DESCRIPTION
52555-32	5MM X 24CM
52555-51	5MM X 33CM
52555-34	5MM X 36CM
52555-35	5MM X 45CM



10MM INSULATED SHAFT

ITEM NO.	DESCRIPTION
52555-50	10MM X 24CM
52555-46	10MM X 33CM
52555-56	10MM X 36CM
52555-48	10MM X 45CM

10MM NON-INSULATED SHAFT

ITEM NO.	DESCRIPTION
52555-55	10MM X 24CM
52555-52	10MM X 33CM
52555-53	10MM X 36CM
52555-54	10MM X 45CM



52555-47-01

SHAFT LOCKING CAP
PK. OF 10

REUSABLE CABLES FOR MONOPOLAR INSTRUMENTS & GENERATORS



GENERATOR END



INSTRUMENT END

ITEM NO.
52005-31

4MM DIA. PLUG (UNIT) &
4MM DIA. FEMALE INST. PLUG



GENERATOR END



INSTRUMENT END

ITEM NO.
52005-32

8MM DIA. "BOVIE" PLUG (UNIT) &
4MM DIA. FEMALE INST. PLUG



HANDLES: Insulated & Carbon Fiber

52555-40-01

INSULATED STAINLESS STEEL
W/ RF POST
(TYPE 1)



52555-40-02

INSULATED STAINLESS STEEL
W/ RF-POST & RATCHET
(TYPE 2)



52555-40-05

INSULATED W/ RF-POST &
RATCHET (TYPE 5)



52555-40-06

LIGHTWEIGHT CARBON
FIBER W/ RF-POST & RATCHET
(TYPE 6)



52555-40-07

LIGHTWEIGHT CARBON-FIBER
W/ RF POST,
RATCHET / RATCHET
DEFEATING (TYPE 7)



52555-40-08

LIGHTWEIGHT CARBON-FIBER
W/ RF POST, ON DEMAND
FRENCH ON/OFF RATCHET
(TYPE 8)



52555-40-09

LIGHTWEIGHT CARBON-FIBER
W/ RF POST, W/ LARGE FINGER
LOOPS
(TYPE 9)



52555-40-10

LIGHTWEIGHT
CARBON-FIBER W/ RF POST,
RATCHET / RATCHET
DEFEATING W/ LARGE FINGER
LOOPS (TYPE 10)



52555-40-14

INSULATED STAINLESS STEEL
LINVATEC-WECK STYLE W/
LONG SHANKS (TYPE 14)



52555-40-17

LIGHTWEIGHT CARBON
FIBER W/ RF POST
(TYPE 17)



52555-40-18

LIGHTWEIGHT CARBON-FIBER
W/ RF POST,
RATCHET / RATCHET
DEFEATING (TYPE 18)



52555-40-23

LIGHTWEIGHT THERMO-
PLASTIC W/ RF POST,
NON-RATCHET (TYPE 23)



52555-40-24

LIGHTWEIGHT THERMO-
PLASTIC W/ RF POST,
W/ RATCHET (TYPE 24)





SUMMIT SERIES HANDLES: Non-Insulated

52555-40-03

NON-INSULATED
STAINLESS STEEL



52555-40-15

NON-INSULATED STAINLESS
STEEL LINVATEC-WECK STYLE
W/ QUICK RELEASE RATCHET &
LONG SHANKS



52555-40-04

NON-INSULATED
STAINLESS STEEL W/ RATCHET



52555-40-16

NON-INSULATED STAINLESS
STEEL W/ SPRING ASSIST
CLOSING



52555-40-11

NON-INSULATED RING AXIAL
HANDLE



52555-40-13

STAINLESS STEEL AXIAL
HANDLE W/ PRECISE
ENGAGEMENT RATCHET



52555-40-12

NON-INSULATED RING
AXIAL HANDLE W/
RATCHET











STYLE C:

ROTATABLE, THREE PIECE MODULAR INSTRUMENT

Dissectors & Graspers

TIP ID.	DIAMETER	LENGTH	INSERT NO.	52555-40-01	52555-40-17	52555-40-18	52555-40-10	52555-40-03	52555-40-04
				INSULATED & CARBON FIBER HANDLES				NON-INSULATED HANDLES	
 MICRO REDDICK OLSEN 12MM JAW	5MM	24CM	52224-011	52224-01C1	52224-01C17	52224-01C18	52224-01C10	52224-01C3	52224-01C4
	5MM	33CM	52255-011	52255-01C1	52255-01C17	52255-01C18	52255-01C10	52255-01C3	52255-01C4
	5MM	36CM	52236-011	52236-01C1	52236-01C17	52236-01C18	52236-01C10	52236-01C3	52236-01C4
	5MM	45CM	52155-011	52155-01C1	52155-01C17	52155-01C18	52155-01C10	52155-01C3	52155-01C4
 STANDARD GRASPER W/ SPOON 12MM JAW	5MM	24CM	52224-021	52224-02C1	52224-02C17	52224-02C18	52224-02C10	52224-02C3	52224-02C4
	5MM	33CM	52255-021	52255-02C1	52255-02C17	52255-02C18	52255-02C10	52255-02C3	52255-02C4
	5MM	36CM	52236-021	52236-02C1	52236-02C17	52236-02C18	52236-02C10	52236-02C3	52236-02C4
	5MM	45CM	52155-021	52155-02C1	52155-02C17	52155-02C18	52155-02C10	52155-02C3	52155-02C4
 STANDARD GRASPER W/ SPOON, LONG 20MM JAW	5MM	24CM	52224-521	52224-52C1	52224-52C17	52224-52C18	52224-52C10	52224-52C3	52224-52C4
	5MM	33CM	52255-521	52255-52C1	52255-52C17	52255-52C18	52255-52C10	52255-52C3	52255-52C4
	5MM	36CM	52236-521	52236-52C1	52236-52C17	52236-52C18	52236-52C10	52236-52C3	52236-52C4
	5MM	45CM	52155-521	52155-52C1	52155-52C17	52155-52C18	52155-52C10	52155-52C3	52155-52C4
 STANDARD GRASPER 12MM JAW	5MM	24CM	52224-031	52224-03C1	52224-03C17	52224-03C18	52224-03C10	52224-03C3	52224-03C4
	5MM	33CM	52255-031	52255-03C1	52255-03C17	52255-03C18	52255-03C10	52255-03C3	52255-03C4
	5MM	36CM	52236-031	52236-03C1	52236-03C17	52236-03C18	52236-03C10	52236-03C3	52236-03C4
	5MM	45CM	52155-031	52155-03C1	52155-03C17	52155-03C18	52155-03C10	52155-03C3	52155-03C4
 BULLET-NOSE GRASPER W/ SPOON 12MM JAW	5MM	24CM	52224-041	52224-04C1	52224-04C17	52224-04C18	52224-04C10	52224-04C3	52224-04C4
	5MM	33CM	52255-041	52255-04C1	52255-04C17	52255-04C18	52255-04C10	52255-04C3	52255-04C4
	5MM	36CM	52236-041	52236-04C1	52236-04C17	52236-04C18	52236-04C10	52236-04C3	52236-04C4
	5MM	45CM	52155-041	52155-04C1	52155-04C17	52155-04C18	52155-04C10	52155-04C3	52155-04C4
 TAPERED DOLPHIN-NOSE 15MM JAW	5MM	24CM	52224-051	52224-05C1	52224-05C17	52224-05C18	52224-05C10	52224-05C3	52224-05C4
	5MM	33CM	52255-051	52255-05C1	52255-05C17	52255-05C18	52255-05C10	52255-05C3	52255-05C4
	5MM	36CM	52236-051	52236-05C1	52236-05C17	52236-05C18	52236-05C10	52236-05C3	52236-05C4
	5MM	45CM	52155-051	52155-05C1	52155-05C17	52155-05C18	52155-05C10	52155-05C3	52155-05C4









STYLE C:

ROTATABLE, THREE PIECE MODULAR INSTRUMENT



Dissectors & Graspers

TIP ID.	DIAMETER	LENGTH	INSERT NO.	52555-40-01	52555-40-17	52555-40-18	52555-40-10	52555-40-03	52555-40-04
				INSULATED & CARBON FIBER HANDLES				NON-INSULATED HANDLES	
 15MM JAW	5MM	24CM	52224-105I	52224-105C1	52224-105C17	52224-105C18	52224-105C10	52224-105C3	52224-105C4
	5MM	33CM	52255-105I	52255-105C1	52255-105C17	52255-105C18	52255-105C10	52255-105C3	52255-105C4
	5MM	36CM	52236-105I	52236-105C1	52236-105C17	52236-105C18	52236-105C10	52236-105C3	52236-105C4
	5MM	45CM	52155-105I	52155-105C1	52155-105C17	52155-105C18	52155-105C10	52155-105C3	52155-105C4
 18MM JAW	5MM	24CM	52224-06I	52224-06C1	52224-06C17	52224-06C18	52224-06C10	52224-06C3	52224-06C4
	5MM	33CM	52255-06I	52255-06C1	52255-06C17	52255-06C18	52255-06C10	52255-06C3	52255-06C4
	5MM	36CM	52236-06I	52236-06C1	52236-06C17	52236-06C18	52236-06C10	52236-06C3	52236-06C4
	5MM	45CM	52155-06I	52155-06C1	52155-06C17	52155-06C18	52155-06C10	52155-06C3	52155-06C4
	10MM	33CM	52102-06I	52102-06C1	52102-06C17	52102-06C18	52102-06C10	52102-06C3	52102-06C4
	10MM	36CM	52103-06I	52103-06C1	52103-06C17	52103-06C18	52103-06C10	52103-06C3	52103-06C4
 18MM JAW	5MM	24CM	52224-106I	52224-106C1	52224-106C17	52224-106C18	52224-106C10	52224-106C3	52224-106C4
	5MM	33CM	52255-106I	52255-106C1	52255-106C17	52255-106C18	52255-106C10	52255-106C3	52255-106C4
	5MM	36CM	52236-106I	52236-106C1	52236-106C17	52236-106C18	52236-106C10	52236-106C3	52236-106C4
	5MM	45CM	52155-106I	52155-106C1	52155-106C17	52155-106C18	52155-106C10	52155-106C3	52155-106C4
 15MM JAW	5MM	24CM	52224-206I	52224-206C1	52224-206C17	52224-206C18	52224-206C10	52224-206C3	52224-206C4
	5MM	33CM	52255-206I	52255-206C1	52255-206C17	52255-206C18	52255-206C10	52255-206C3	52255-206C4
	5MM	36CM	52236-206I	52236-206C1	52236-206C17	52236-206C18	52236-206C10	52236-206C3	52236-206C4
	5MM	45CM	52155-206I	52155-206C1	52155-206C17	52155-206C18	52155-206C10	52155-206C3	52155-206C4
 22MM JAW	5MM	24CM	52224-07I	52224-07C1	52224-07C17	52224-07C18	52224-07C10	52224-07C3	52224-07C4
	5MM	33CM	52255-07I	52255-07C1	52255-07C17	52255-07C18	52255-07C10	52255-07C3	52255-07C4
	5MM	36CM	52236-07I	52236-07C1	52236-07C17	52236-07C18	52236-07C10	52236-07C3	52236-07C4
	5MM	45CM	52155-07I	52155-07C1	52155-07C17	52155-07C18	52155-07C10	52155-07C3	52155-07C4
	10MM	33CM	52102-07I	52102-07C1	52102-07C17	52102-07C18	52102-07C10	52102-07C3	52102-07C4
	10MM	36CM	52103-07I	52103-07C1	52103-07C17	52103-07C18	52103-07C10	52103-07C3	52103-07C4
 12MM TIP	5MM	24CM	52224-59I	52224-59C1	52224-59C17	52224-59C18	52224-59C10	52224-59C3	52224-59C4
	5MM	33CM	52255-59I	52255-59C1	52255-59C17	52255-59C18	52255-59C10	52255-59C3	52255-59C4
	5MM	36CM	52236-59I	52236-59C1	52236-59C17	52236-59C18	52236-59C10	52236-59C3	52236-59C4
	5MM	45CM	52155-59I	52155-59C1	52155-59C17	52155-59C18	52155-59C10	52155-59C3	52155-59C4
	10MM	33CM	52102-59I	52102-59C1	52102-59C17	52102-59C18	52102-59C10	52102-59C3	52102-59C4
	10MM	36CM	52103-59I	52103-59C1	52103-59C17	52103-59C18	52103-59C10	52103-59C3	52103-59C4
10MM	45CM	52101-59I	52101-59C1	52101-59C17	52101-59C18	52101-59C10	52101-59C3	52101-59C4	



STYLE C:

ROTATABLE, THREE PIECE MODULAR INSTRUMENT

Dissectors & Graspers







TIP ID.	DIAMETER	LENGTH	INSERT NO.	52555-40-01	52555-40-17	52555-40-18	52555-40-10	52555-40-03	52555-40-04
				INSULATED & CARBON FIBER HANDLES				NON-INSULATED HANDLES	
45 DEGREE ANGLED MIXTER 20MM JAW	5MM	24CM	52224-08I	52224-08C1	52224-08C17	52224-08C18	52224-08C10	52224-08C3	52224-08C4
	5MM	33CM	52255-08I	52255-08C1	52255-08C17	52255-08C18	52255-08C10	52255-08C3	52255-08C4
	5MM	36CM	52236-08I	52236-08C1	52236-08C17	52236-08C18	52236-08C10	52236-08C3	52236-08C4
	5MM	45CM	52155-08I	52155-08C1	52155-08C17	52155-08C18	52155-08C10	52155-08C3	52155-08C4
	10MM	33CM	52102-08I	52102-08C1	52102-08C17	52102-08C18	52102-08C10	52102-08C3	52102-08C4
	10MM	36CM	52103-08I	52103-08C1	52103-08C17	52103-08C18	52103-08C10	52103-08C3	52103-08C4
	10MM	45CM	52101-08I	52101-08C1	52101-08C17	52101-08C18	52101-08C10	52101-08C3	52101-08C4
DUCKBILL GRASPER 12MM JAW	5MM	24CM	52224-09I	52224-09C1	52224-09C17	52224-09C18	52224-09C10	52224-09C3	52224-09C4
	5MM	33CM	52255-09I	52255-09C1	52255-09C17	52255-09C18	52255-09C10	52255-09C3	52255-09C4
	5MM	36CM	52236-09I	52236-09C1	52236-09C17	52236-09C18	52236-09C10	52236-09C3	52236-09C4
	5MM	45CM	52155-09I	52155-09C1	52155-09C17	52155-09C18	52155-09C10	52155-09C3	52155-09C4
NEEDLE-NOSE GRASPER 20MM JAW	5MM	24CM	52224-10I	52224-10C1	52224-10C17	52224-10C18	52224-10C10	52224-10C3	52224-10C4
	5MM	33CM	52255-10I	52255-10C1	52255-10C17	52255-10C18	52255-10C10	52255-10C3	52255-10C4
	5MM	36CM	52236-10I	52236-10C1	52236-10C17	52236-10C18	52236-10C10	52236-10C3	52236-10C4
	5MM	45CM	52155-10I	52155-10C1	52155-10C17	52155-10C18	52155-10C10	52155-10C3	52155-10C4
KELLY GRASPER 14MM JAW	5MM	24CM	52224-11I	52224-11C1	52224-11C17	52224-11C18	52224-11C10	52224-11C3	52224-11C4
	5MM	33CM	52255-11I	52255-11C1	52255-11C17	52255-11C18	52255-11C10	52255-11C3	52255-11C4
	5MM	36CM	52236-11I	52236-11C1	52236-11C17	52236-11C18	52236-11C10	52236-11C3	52236-11C4
	5MM	45CM	52155-11I	52155-11C1	52155-11C17	52155-11C18	52155-11C10	52155-11C3	52155-11C4
RIGHT ANGLE, LONG REACH GRASPER 22MM JAW	5MM	24CM	52224-53I	52224-53C1	52224-53C17	52224-53C18	52224-53C10	52224-53C3	52224-53C4
	5MM	33CM	52255-53I	52255-53C1	52255-53C17	52255-53C18	52255-53C10	52255-53C3	52255-53C4
	5MM	36CM	52236-53I	52236-53C1	52236-53C17	52236-53C18	52236-53C10	52236-53C3	52236-53C4
	5MM	45CM	52155-53I	52155-53C1	52155-53C17	52155-53C18	52155-53C10	52155-53C3	52155-53C4
PETELIN DISSECTOR, 60 DEGREE ANGLE, SA 10MM JAW	5MM	24CM	52224-12I	52224-12C1	52224-12C17	52224-12C18	52224-12C10	52224-12C3	52224-12C4
	5MM	33CM	52255-12I	52255-12C1	52255-12C17	52255-12C18	52255-12C10	52255-12C3	52255-12C4
	5MM	36CM	52236-12I	52236-12C1	52236-12C17	52236-12C18	52236-12C10	52236-12C3	52236-12C4
	5MM	45CM	52155-12I	52155-12C1	52155-12C17	52155-12C18	52155-12C10	52155-12C3	52155-12C4



STYLE C:

ROTATABLE, THREE PIECE MODULAR INSTRUMENT

Dissectors & Graspers







TIP ID.	DIAMETER	LENGTH	INSERT NO.	52555-40-01	52555-40-17	52555-40-18	52555-40-10	52555-40-03	52555-40-04
				INSULATED & CARBON FIBER HANDLES				NON-INSULATED HANDLES	
 PETELIN DISSECTOR, 30 DEGREE ANGLE, SA 10MM JAW	5MM	24CM	52224-13I	52224-13C1	52224-13C17	52224-13C18	52224-13C10	52224-13C3	52224-13C4
	5MM	33CM	52255-13I	52255-13C1	52255-13C17	52255-13C18	52255-13C10	52255-13C3	52255-13C4
	5MM	36CM	52236-13I	52236-13C1	52236-13C17	52236-13C18	52236-13C10	52236-13C3	52236-13C4
	5MM	45CM	52155-13I	52155-13C1	52155-13C17	52155-13C18	52155-13C10	52155-13C3	52155-13C4
 MICRO GRASPER, FENESTRATED 10MM JAW	5MM	24CM	52224-14I	52224-14C1	52224-14C17	52224-14C18	52224-14C10	52224-14C3	52224-14C4
	5MM	33CM	52255-14I	52255-14C1	52255-14C17	52255-14C18	52255-14C10	52255-14C3	52255-14C4
	5MM	36CM	52236-14I	52236-14C1	52236-14C17	52236-14C18	52236-14C10	52236-14C3	52236-14C4
	5MM	45CM	52155-14I	52155-14C1	52155-14C17	52155-14C18	52155-14C10	52155-14C3	52155-14C4
 COBRA GRASPER, DOUBLE-ACTION 10MM JAW	5MM	24CM	52224-15I	52224-15C1	52224-15C17	52224-15C18	52224-15C10	52224-15C3	52224-15C4
	5MM	33CM	52255-15I	52255-15C1	52255-15C17	52255-15C18	52255-15C10	52255-15C3	52255-15C4
	5MM	36CM	52236-15I	52236-15C1	52236-15C17	52236-15C18	52236-15C10	52236-15C3	52236-15C4
	5MM	45CM	52155-15I	52155-15C1	52155-15C17	52155-15C18	52155-15C10	52155-15C3	52155-15C4
 BABCOCK GRASPER, FENESTRATED TIP 30MM JAW	5MM	24CM	52224-16I	52224-16C1	52224-16C17	52224-16C18	52224-16C10	52224-16C3	52224-16C4
	5MM	33CM	52255-16I	52255-16C1	52255-16C17	52255-16C18	52255-16C10	52255-16C3	52255-16C4
	5MM	36CM	52236-16I	52236-16C1	52236-16C17	52236-16C18	52236-16C10	52236-16C3	52236-16C4
	5MM	45CM	52155-16I	52155-16C1	52155-16C17	52155-16C18	52155-16C10	52155-16C3	52155-16C4
	10MM	33CM	52102-16I	52102-16C1	52102-16C17	52102-16C18	52102-16C10	52102-16C3	52102-16C4
	10MM	36CM	52103-16I	52103-16C1	52103-16C17	52103-16C18	52103-16C10	52103-16C3	52103-16C4
 BABCOCK GRASPER, AXIS STYLE, FENESTRATED 30MM JAW	5MM	24CM	52224-116I	52224-116C1	52224-116C17	52224-116C18	52224-116C10	52224-116C3	52224-116C4
	5MM	33CM	52255-116I	52255-116C1	52255-116C17	52255-116C18	52255-116C10	52255-116C3	52255-116C4
	5MM	36CM	52236-116I	52236-116C1	52236-116C17	52236-116C18	52236-116C10	52236-116C3	52236-116C4
	5MM	45CM	52155-116I	52155-116C1	52155-116C17	52155-116C18	52155-116C10	52155-116C3	52155-116C4
 BABCOCK GRASPER, SHORT DELICATE 20MM JAW	5MM	24CM	52224-17I	52224-17C1	52224-17C17	52224-17C18	52224-17C10	52224-17C3	52224-17C4
	5MM	33CM	52255-17I	52255-17C1	52255-17C17	52255-17C18	52255-17C10	52255-17C3	52255-17C4
	5MM	36CM	52236-17I	52236-17C1	52236-17C17	52236-17C18	52236-17C10	52236-17C3	52236-17C4
	5MM	45CM	52155-17I	52155-17C1	52155-17C17	52155-17C18	52155-17C10	52155-17C3	52155-17C4



STYLE C:

ROTATABLE, THREE PIECE MODULAR INSTRUMENT

Dissectors & Graspers













TIP ID.	DIAMETER	LENGTH	INSERT NO.	52555-40-01	52555-40-17	52555-40-18	52555-40-10	52555-40-03	52555-40-04
				INSULATED & CARBON FIBER HANDLES				NON-INSULATED HANDLES	
ALLIS GRASPER, SHORT VERSION, SA  15MM JAW	5MM	24CM	52224-18I	52224-18C1	52224-18C17	52224-18C18	52224-18C10	52224-18C3	52224-18C4
	5MM	33CM	52255-18I	52255-18C1	52255-18C17	52255-18C18	52255-18C10	52255-18C3	52255-18C4
	5MM	36CM	52236-18I	52236-18C1	52236-18C17	52236-18C18	52236-18C10	52236-18C3	52236-18C4
	5MM	45CM	52155-18I	52155-18C1	52155-18C17	52155-18C18	52155-18C10	52155-18C3	52155-18C4
ALLIS, SHORT VERSION, 3 X 4 TEETH, SERRATED  12MM JAW	5MM	24CM	52224-19I	52224-19C1	52224-19C17	52224-19C18	52224-19C10	52224-19C3	52224-19C4
	5MM	33CM	52255-19I	52255-19C1	52255-19C17	52255-19C18	52255-19C10	52255-19C3	52255-19C4
	5MM	36CM	52236-19I	52236-19C1	52236-19C17	52236-19C18	52236-19C10	52236-19C3	52236-19C4
	5MM	45CM	52155-19I	52155-19C1	52155-19C17	52155-19C18	52155-19C10	52155-19C3	52155-19C4
ALLIS, SHORT VERSION, DOUBLE ROW OF TEETH, SERRATED  12MM JAW	5MM	24CM	52224-119I	52224-119C1	52224-119C17	52224-119C18	52224-119C10	52224-119C3	52224-119C4
	5MM	33CM	52255-119I	52255-119C1	52255-119C17	52255-119C18	52255-119C10	52255-119C3	52255-119C4
	5MM	36CM	52236-119I	52236-119C1	52236-119C17	52236-119C18	52236-119C10	52236-119C3	52236-119C4
	5MM	45CM	52155-119I	52155-119C1	52155-119C17	52155-119C18	52155-119C10	52155-119C3	52155-119C4
ALLIS, LONG VERSION, DOUBLE ROW OF TEETH, SERRATED  25MM JAW	5MM	24CM	52224-219I	52224-219C1	52224-219C17	52224-219C18	52224-219C10	52224-219C3	52224-219C4
	5MM	33CM	52255-219I	52255-219C1	52255-219C17	52255-219C18	52255-219C10	52255-219C3	52255-219C4
	5MM	36CM	52236-219I	52236-219C1	52236-219C17	52236-219C18	52236-219C10	52236-219C3	52236-219C4
	5MM	45CM	52155-219I	52155-219C1	52155-219C17	52155-219C18	52155-219C10	52155-219C3	52155-219C4
ALLIS GRASPER, MEDIUM, WECK STYLE  20MM JAW	5MM	24CM	52224-20I	52224-20C1	52224-20C17	52224-20C18	52224-20C10	52224-20C3	52224-20C4
	5MM	33CM	52255-20I	52255-20C1	52255-20C17	52255-20C18	52255-20C10	52255-20C3	52255-20C4
	5MM	36CM	52236-20I	52236-20C1	52236-20C17	52236-20C18	52236-20C10	52236-20C3	52236-20C4
	5MM	45CM	52155-20I	52155-20C1	52155-20C17	52155-20C18	52155-20C10	52155-20C3	52155-20C4
ALLIS GRASPER, STANDARD VERSION  30MM JAW	5MM	24CM	52224-21I	52224-21C1	52224-21C17	52224-21C18	52224-21C10	52224-21C3	52224-21C4
	5MM	33CM	52255-21I	52255-21C1	52255-21C17	52255-21C18	52255-21C10	52255-21C3	52255-21C4
	5MM	36CM	52236-21I	52236-21C1	52236-21C17	52236-21C18	52236-21C10	52236-21C3	52236-21C4
	5MM	45CM	52155-21I	52155-21C1	52155-21C17	52155-21C18	52155-21C10	52155-21C3	52155-21C4
	10MM	33CM	52102-21I	52102-21C1	52102-21C17	52102-21C18	52102-21C10	52102-21C3	52102-21C4
	10MM	36CM	52103-21I	52103-21C1	52103-21C17	52103-21C18	52103-21C10	52103-21C3	52103-21C4
10MM	45CM	52101-21I	52101-21C1	52101-21C17	52101-21C18	52101-21C10	52101-21C3	52101-21C4	

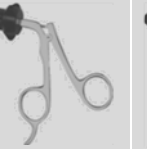

STYLE C:

ROTATABLE, THREE PIECE MODULAR INSTRUMENT

Dissectors & Graspers

TIP ID.	DIAMETER	LENGTH	INSERT NO.	52555-40-01	52555-40-17	52555-40-18	52555-40-10	52555-40-03	52555-40-04
									
				INSULATED & CARBON FIBER HANDLES				NON-INSULATED HANDLES	
ALLIS GRASPER, TC, STANDARD VERSION  35MM JAW	5MM	24CM	52224-57I	52224-57C1	52224-57C17	52224-57C18	52224-57C10	52224-57C3	52224-57C4
	5MM	33CM	52255-57I	52255-57C1	52255-57C17	52255-57C18	52255-57C10	52255-57C3	52255-57C4
	5MM	36CM	52236-57I	52236-57C1	52236-57C17	52236-57C18	52236-57C10	52236-57C3	52236-57C4
	5MM	45CM	52155-57I	52155-57C1	52155-57C17	52155-57C18	52155-57C10	52155-57C3	52155-57C4
DEBAKEY GRASPER, 20MM JAW  20MM JAW	5MM	24CM	52224-22I	52224-22C1	52224-22C17	52224-22C18	52224-22C10	52224-22C3	52224-22C4
	5MM	33CM	52255-22I	52255-22C1	52255-22C17	52255-22C18	52255-22C10	52255-22C3	52255-22C4
	5MM	36CM	52236-22I	52236-22C1	52236-22C17	52236-22C18	52236-22C10	52236-22C3	52236-22C4
	5MM	45CM	52155-22I	52155-22C1	52155-22C17	52155-22C18	52155-22C10	52155-22C3	52155-22C4
DEBAKEY GRASPER, 40MM JAW  40MM JAW	5MM	24CM	52224-23I	52224-23C1	52224-23C17	52224-23C18	52224-23C10	52224-23C3	52224-23C4
	5MM	33CM	52255-23I	52255-23C1	52255-23C17	52255-23C18	52255-23C10	52255-23C3	52255-23C4
	5MM	36CM	52236-23I	52236-23C1	52236-23C17	52236-23C18	52236-23C10	52236-23C3	52236-23C4
	5MM	45CM	52155-23I	52155-23C1	52155-23C17	52155-23C18	52155-23C10	52155-23C3	52155-23C4
	10MM	33CM	52102-22I	52102-22C1	52102-22C17	52102-22C18	52102-22C10	52102-22C3	52102-22C4
	10MM	36CM	52103-22I	52103-22C1	52103-22C17	52103-22C18	52103-22C10	52103-22C3	52103-22C4
DEBAKEY GRASPER, 60MM JAW  60MM	5MM	24CM	52224-160I	52224-160C1	52224-160C17	52224-160C18	52224-160C10	52224-160C3	52224-160C4
	5MM	33CM	52255-160I	52255-160C1	52255-160C17	52255-160C18	52255-160C10	52255-160C3	52255-160C4
	5MM	36CM	52236-160I	52236-160C1	52236-160C17	52236-160C18	52236-160C10	52236-160C3	52236-160C4
	5MM	45CM	52155-160I	52155-160C1	52155-160C17	52155-160C18	52155-160C10	52155-160C3	52155-160C4
	10MM	33CM	52102-23I	52102-23C1	52102-23C17	52102-23C18	52102-23C10	52102-23C3	52102-23C4
	10MM	36CM	52103-23I	52103-23C1	52103-23C17	52103-23C18	52103-23C10	52103-23C3	52103-23C4
HUNTER DEBAKEY, FENESTRATED, 20MM  20MM JAW	5MM	24CM	52224-58I	52224-58C1	52224-58C17	52224-58C18	52224-58C10	52224-58C3	52224-58C4
	5MM	33CM	52255-58I	52255-58C1	52255-58C17	52255-58C18	52255-58C10	52255-58C3	52255-58C4
	5MM	36CM	52236-58I	52236-58C1	52236-58C17	52236-58C18	52236-58C10	52236-58C3	52236-58C4
	5MM	45CM	52155-58I	52155-58C1	52155-58C17	52155-58C18	52155-58C10	52155-58C3	52155-58C4
HUNTER DEBAKEY, FENESTRATED, 40MM  40MM JAW	5MM	24CM	52224-159I	52224-159C1	52224-159C17	52224-159C18	52224-159C10	52224-159C3	52224-159C4
	5MM	33CM	52255-159I	52255-159C1	52255-159C17	52255-159C18	52255-159C10	52255-159C3	52255-159C4
	5MM	36CM	52236-159I	52236-159C1	52236-159C17	52236-159C18	52236-159C10	52236-159C3	52236-159C4
	5MM	45CM	52155-159I	52155-159C1	52155-159C17	52155-159C18	52155-159C10	52155-159C3	52155-159C4



STYLE C:

ROTATABLE, THREE PIECE MODULAR INSTRUMENT



Dissectors & Graspers







TIP ID.	DIAMETER	LENGTH	INSERT NO.	52555-40-01	52555-40-17	52555-40-18	52555-40-10	52555-40-03	52555-40-04
				INSULATED & CARBON FIBER HANDLES				NON-INSULATED HANDLES	
HUNTER DEBAKEY, FENESTRATED, 60MM 60MM JAW	5MM	24CM	52224-160I	52224-160C1	52224-160C17	52224-160C18	52224-160C10	52224-160C3	52224-160C4
	5MM	33CM	52255-160I	52255-160C1	52255-160C17	52255-160C18	52255-160C10	52255-160C3	52255-160C4
	5MM	36CM	52236-160I	52236-160C1	52236-160C17	52236-160C18	52236-160C10	52236-160C3	52236-160C4
	5MM	45CM	52155-160I	52155-160C1	52155-160C17	52155-160C18	52155-160C10	52155-160C3	52155-160C4
DEBAKEY GRASPER, CURVED 30MM JAW	5MM	24CM	52224-46I	52224-46C1	52224-46C17	52224-46C18	52224-46C10	52224-46C3	52224-46C4
	5MM	33CM	52255-46I	52255-46C1	52255-46C17	52255-46C18	52255-46C10	52255-46C3	52255-46C4
	5MM	36CM	52236-46I	52236-46C1	52236-46C17	52236-46C18	52236-46C10	52236-46C3	52236-46C4
	5MM	45CM	52155-46I	52155-46C1	52155-46C17	52155-46C18	52155-46C10	52155-46C3	52155-46C4
DEBAKEY MARYLAND GRASPER 35MM JAW	5MM	24CM	52224-149I	52224-149C1	52224-149C17	52224-149C18	52224-149C10	52224-149C3	52224-149C4
	5MM	33CM	52255-149I	52255-149C1	52255-149C17	52255-149C18	52255-149C10	52255-149C3	52255-149C4
	5MM	36CM	52236-149I	52236-149C1	52236-149C17	52236-149C18	52236-149C10	52236-149C3	52236-149C4
	5MM	45CM	52155-149I	52155-149C1	52155-149C17	52155-149C18	52155-149C10	52155-149C3	52155-149C4
GLASSMAN ATRAUMATIC GRASPER 30MM JAW	5MM	24CM	52224-24I	52224-24C1	52224-24C17	52224-24C18	52224-24C10	52224-24C3	52224-24C4
	5MM	33CM	52255-24I	52255-24C1	52255-24C17	52255-24C18	52255-24C10	52255-24C3	52255-24C4
	5MM	36CM	52236-24I	52236-24C1	52236-24C17	52236-24C18	52236-24C10	52236-24C3	52236-24C4
	5MM	45CM	52155-24I	52155-24C1	52155-24C17	52155-24C18	52155-24C10	52155-24C3	52155-24C4
GRASPER, CROSS SERRATED, SINGLE ACTION 10MM JAW	5MM	24CM	52224-25I	52224-25C1	52224-25C17	52224-25C18	52224-25C10	52224-25C3	52224-25C4
	5MM	33CM	52255-25I	52255-25C1	52255-25C17	52255-25C18	52255-25C10	52255-25C3	52255-25C4
	5MM	36CM	52236-25I	52236-25C1	52236-25C17	52236-25C18	52236-25C10	52236-25C3	52236-25C4
	5MM	45CM	52155-25I	52155-25C1	52155-25C17	52155-25C18	52155-25C10	52155-25C3	52155-25C4
DOUBLE CUP FUNDUS MAXI GRASPER 16MM JAW	5MM	24CM	52224-26I	52224-26C1	52224-26C17	52224-26C18	52224-26C10	52224-26C3	52224-26C4
	5MM	33CM	52255-26I	52255-26C1	52255-26C17	52255-26C18	52255-26C10	52255-26C3	52255-26C4
	5MM	36CM	52236-26I	52236-26C1	52236-26C17	52236-26C18	52236-26C10	52236-26C3	52236-26C4
	5MM	45CM	52155-26I	52155-26C1	52155-26C17	52155-26C18	52155-26C10	52155-26C3	52155-26C4



STYLE C:

ROTATABLE, THREE PIECE MODULAR INSTRUMENT

Dissectors & Graspers

TIP ID.	DIAMETER	LENGTH	INSERT NO.	52555-40-01	52555-40-17	52555-40-18	52555-40-10	52555-40-03	52555-40-04
				INSULATED & CARBON FIBER HANDLES				NON-INSULATED HANDLES	
ALLIGATOR GRASPER, RETRO-FACING TEETH, 10MM JAW  10MM JAW	5MM	24CM	52224-29I	52224-29C1	52224-29C17	52224-29C18	52224-29C10	52224-29C3	52224-29C4
	5MM	33CM	52255-29I	52255-29C1	52255-29C17	52255-29C18	52255-29C10	52255-29C3	52255-29C4
	5MM	36CM	52236-29I	52236-29C1	52236-29C17	52236-29C18	52236-29C10	52236-29C3	52236-29C4
	5MM	45CM	52155-29I	52155-29C1	52155-29C17	52155-29C18	52155-29C10	52155-29C3	52155-29C4
ALLIGATOR GRASPER, RETRO-FACING TEETH, SINGLE ACTION  15MM JAW	5MM	24CM	52224-30I	52224-30C1	52224-30C17	52224-30C18	52224-30C10	52224-30C3	52224-30C4
	5MM	33CM	52255-30I	52255-30C1	52255-30C17	52255-30C18	52255-30C10	52255-30C3	52255-30C4
	5MM	36CM	52236-30I	52236-30C1	52236-30C17	52236-30C18	52236-30C10	52236-30C3	52236-30C4
	5MM	45CM	52155-30I	52155-30C1	52155-30C17	52155-30C18	52155-30C10	52155-30C3	52155-30C4
CUP SHAPED GRASPER, W/ RETRO-FACING TEETH  10MM JAW	5MM	24CM	52224-31I	52224-31C1	52224-31C17	52224-31C18	52224-31C10	52224-31C3	52224-31C4
	5MM	33CM	52255-31I	52255-31C1	52255-31C17	52255-31C18	52255-31C10	52255-31C3	52255-31C4
	5MM	36CM	52236-31I	52236-31C1	52236-31C17	52236-31C18	52236-31C10	52236-31C3	52236-31C4
	5MM	45CM	52155-31I	52155-31C1	52155-31C17	52155-31C18	52155-31C10	52155-31C3	52155-31C4
WAVE GRASPER, LONG BEVELED EDGE, DOUBLE ACTION  22MM JAW	5MM	24CM	52224-32I	52224-32C1	52224-32C17	52224-32C18	52224-32C10	52224-32C3	52224-32C4
	5MM	33CM	52255-32I	52255-32C1	52255-32C17	52255-32C18	52255-32C10	52255-32C3	52255-32C4
	5MM	36CM	52236-32I	52236-32C1	52236-32C17	52236-32C18	52236-32C10	52236-32C3	52236-32C4
	5MM	45CM	52155-32I	52155-32C1	52155-32C17	52155-32C18	52155-32C10	52155-32C3	52155-32C4
WAVE GRASPER, LONG BEVELED EDGE, SINGLE ACTION  22MM JAW	5MM	24CM	52224-33I	52224-33C1	52224-33C17	52224-33C18	52224-33C10	52224-33C3	52224-33C4
	5MM	33CM	52255-33I	52255-33C1	52255-33C17	52255-33C18	52255-33C10	52255-33C3	52255-33C4
	5MM	36CM	52236-33I	52236-33C1	52236-33C17	52236-33C18	52236-33C10	52236-33C3	52236-33C4
	5MM	45CM	52155-33I	52155-33C1	52155-33C17	52155-33C18	52155-33C10	52155-33C3	52155-33C4
CLAW GRASPER, 2 X 3 TEETH, SINGLE ACTION  20MM JAW	5MM	24CM	52224-36I	52224-36C1	52224-36C17	52224-36C18	52224-36C10	52224-36C3	52224-36C4
	5MM	33CM	52255-36I	52255-36C1	52255-36C17	52255-36C18	52255-36C10	52255-36C3	52255-36C4
	5MM	36CM	52236-36I	52236-36C1	52236-36C17	52236-36C18	52236-36C10	52236-36C3	52236-36C4
	5MM	45CM	52155-36I	52155-36C1	52155-36C17	52155-36C18	52155-36C10	52155-36C3	52155-36C4
	10MM	33CM	52102-36I	52102-36C1	52102-36C17	52102-36C18	52102-36C10	52102-36C3	52102-36C4
	10MM	45CM	52101-36I	52101-36C1	52101-36C17	52101-36C18	52101-36C10	52101-36C3	52101-36C4



STYLE C:

ROTATABLE, THREE PIECE MODULAR INSTRUMENT



Dissectors & Graspers

TIP ID.	DIAMETER	LENGTH	INSERT NO.	52555-40-01	52555-40-17	52555-40-18	52555-40-10	52555-40-03	52555-40-04
				INSULATED & CARBON FIBER HANDLES				NON-INSULATED HANDLES	
CLAW GRASPER, 2 X 3 TEETH, W/ XTRA ROW OF TEETH 20MM JAW	5MM	24CM	52224-136I	52224-136C1	52224-136C17	52224-136C18	52224-136C10	52224-136C3	52224-136C4
	5MM	33CM	52255-136I	52255-136C1	52255-136C17	52255-136C18	52255-136C10	52255-136C3	52255-136C4
	5MM	36CM	52236-136I	52236-136C1	52236-136C17	52236-136C18	52236-136C10	52236-136C3	52236-136C4
	5MM	45CM	52155-136I	52155-136C1	52155-136C17	52155-136C18	52155-136C10	52155-136C3	52155-136C4
RETRACTION GRASPER, 2 X 3 TEETH, COBRA STYLE, DA 20MM JAW	5MM	24CM	52224-34I	52224-34C1	52224-34C17	52224-34C18	52224-34C10	52224-34C3	52224-34C4
	5MM	33CM	52255-34I	52255-34C1	52255-34C17	52255-34C18	52255-34C10	52255-34C3	52255-34C4
	5MM	36CM	52236-34I	52236-34C1	52236-34C17	52236-34C18	52236-34C10	52236-34C3	52236-34C4
	5MM	45CM	52155-34I	52155-34C1	52155-34C17	52155-34C18	52155-34C10	52155-34C3	52155-34C4
RETRACTION GRASPER, 2 X 3 TEETH, COBRA STYLE, SA 20MM JAW	5MM	24CM	52224-35I	52224-35C1	52224-35C17	52224-35C18	52224-35C10	52224-35C3	52224-35C4
	5MM	33CM	52255-35I	52255-35C1	52255-35C17	52255-35C18	52255-35C10	52255-35C3	52255-35C4
	5MM	36CM	52236-35I	52236-35C1	52236-35C17	52236-35C18	52236-35C10	52236-35C3	52236-35C4
	5MM	45CM	52155-35I	52155-35C1	52155-35C17	52155-35C18	52155-35C10	52155-35C3	52155-35C4
RETRACTION GRASPER, 2 X 3 TEETH, JARIT STYLE, DA 20MM JAW	5MM	24CM	52224-134I	52224-134C1	52224-134C17	52224-134C18	52224-134C10	52224-134C3	52224-134C4
	5MM	33CM	52255-134I	52255-134C1	52255-134C17	52255-134C18	52255-134C10	52255-134C3	52255-134C4
	5MM	36CM	52236-134I	52236-134C1	52236-134C17	52236-134C18	52236-134C10	52236-134C3	52236-134C4
	5MM	45CM	52155-134I	52155-134C1	52155-134C17	52155-134C18	52155-134C10	52155-134C3	52155-134C4
RETRACTION GRASPER, 2 X 3 TEETH, JARIT STYLE, SA 20MM JAW	5MM	24CM	52224-135I	52224-135C1	52224-135C17	52224-135C18	52224-135C10	52224-135C3	52224-135C4
	5MM	33CM	52255-135I	52255-135C1	52255-135C17	52255-135C18	52255-135C10	52255-135C3	52255-135C4
	5MM	36CM	52236-135I	52236-135C1	52236-135C17	52236-135C18	52236-135C10	52236-135C3	52236-135C4
	5MM	45CM	52155-135I	52155-135C1	52155-135C17	52155-135C18	52155-135C10	52155-135C3	52155-135C4
ATRUAMATIC FENESTRATED GRASPER, CURVED 16MM JAW	5MM	24CM	52224-37I	52224-37C1	52224-37C17	52224-37C18	52224-37C10	52224-37C3	52224-37C4
	5MM	33CM	52255-37I	52255-37C1	52255-37C17	52255-37C18	52255-37C10	52255-37C3	52255-37C4
	5MM	36CM	52236-37I	52236-37C1	52236-37C17	52236-37C18	52236-37C10	52236-37C3	52236-37C4
	5MM	45CM	52155-37I	52155-37C1	52155-37C17	52155-37C18	52155-37C10	52155-37C3	52155-37C4









STYLE C:

ROTATABLE, THREE PIECE MODULAR INSTRUMENT



Dissectors & Graspers







TIP ID.	DIAMETER	LENGTH	INSERT NO.	52555-40-01	52555-40-17	52555-40-18	52555-40-10	52555-40-03	52555-40-04
				INSULATED & CARBON FIBER HANDLES				NON-INSULATED HANDLES	
 FENESTRATED GRASPER, 16MM JAW 16MM JAW	5MM	24CM	52224-38I	52224-38C1	52224-38C17	52224-38C18	52224-38C10	52224-38C3	52224-38C4
	5MM	33CM	52255-38I	52255-38C1	52255-38C17	52255-38C18	52255-38C10	52255-38C3	52255-38C4
	5MM	36CM	52236-38I	52236-38C1	52236-38C17	52236-38C18	52236-38C10	52236-38C3	52236-38C4
	5MM	45CM	52155-38I	52155-38C1	52155-38C17	52155-38C18	52155-38C10	52155-38C3	52155-38C4
 FENESTRATED GRASPER, 20MM JAW 22MM JAW	5MM	24CM	52224-39I	52224-39C1	52224-39C17	52224-39C18	52224-39C10	52224-39C3	52224-39C4
	5MM	33CM	52255-39I	52255-39C1	52255-39C17	52255-39C18	52255-39C10	52255-39C3	52255-39C4
	5MM	36CM	52236-39I	52236-39C1	52236-39C17	52236-39C18	52236-39C10	52236-39C3	52236-39C4
	5MM	45CM	52155-39I	52155-39C1	52155-39C17	52155-39C18	52155-39C10	52155-39C3	52155-39C4
 FENESTRATED GRASPER, 40MM JAW 40MM JAW	5MM	24CM	52224-40I	52224-40C1	52224-40C17	52224-40C18	52224-40C10	52224-40C3	52224-40C4
	5MM	33CM	52255-40I	52255-40C1	52255-40C17	52255-40C18	52255-40C10	52255-40C3	52255-40C4
	5MM	36CM	52236-40I	52236-40C1	52236-40C17	52236-40C18	52236-40C10	52236-40C3	52236-40C4
	5MM	45CM	52155-40I	52155-40C1	52155-40C17	52155-40C18	52155-40C10	52155-40C3	52155-40C4
 JOHAN FENESTRATED GRASPER, 20MM TIP, SINGLE ACTION 20MM JAW	5MM	24CM	52224-41I	52224-41C1	52224-41C17	52224-41C18	52224-41C10	52224-41C3	52224-41C4
	5MM	33CM	52255-41I	52255-41C1	52255-41C17	52255-41C18	52255-41C10	52255-41C3	52255-41C4
	5MM	36CM	52236-41I	52236-41C1	52236-41C17	52236-41C18	52236-41C10	52236-41C3	52236-41C4
	5MM	45CM	52155-41I	52155-41C1	52155-41C17	52155-41C18	52155-41C10	52155-41C3	52155-41C4
 JOHAN FENESTRATED GRASPER, 45MM TIP, SINGLE ACTION 45MM JAW	5MM	24CM	52224-42I	52224-42C1	52224-42C17	52224-42C18	52224-42C10	52224-42C3	52224-42C4
	5MM	33CM	52255-42I	52255-42C1	52255-42C17	52255-42C18	52255-42C10	52255-42C3	52255-42C4
	5MM	36CM	52236-42I	52236-42C1	52236-42C17	52236-42C18	52236-42C10	52236-42C3	52236-42C4
	5MM	45CM	52155-42I	52155-42C1	52155-42C17	52155-42C18	52155-42C10	52155-42C3	52155-42C4
 DOUBLE FENESTRATED GRASPER, 25MM JAW 25MM JAW	5MM	24CM	52224-139I	52224-139C1	52224-139C17	52224-139C18	52224-139C10	52224-139C3	52224-139C4
	5MM	33CM	52255-139I	52255-139C1	52255-139C17	52255-139C18	52255-139C10	52255-139C3	52255-139C4
	5MM	36CM	52236-139I	52236-139C1	52236-139C17	52236-139C18	52236-139C10	52236-139C3	52236-139C4
	5MM	45CM	52155-139I	52155-139C1	52155-139C17	52155-139C18	52155-139C10	52155-139C3	52155-139C4



STYLE C:

ROTATABLE, THREE PIECE MODULAR INSTRUMENT

Dissectors & Graspers





TIP ID.	DIAMETER	LENGTH	INSERT NO.	52555-40-01	52555-40-17	52555-40-18	52555-40-10	52555-40-03	52555-40-04
				INSULATED & CARBON FIBER HANDLES				NON-INSULATED HANDLES	
KOCHER GRASPER, 1 X 2 TEETH, SINGLE ACTION  15MM JAW	5MM	24CM	52224-43I	52224-43C1	52224-43C17	52224-43C18	52224-43C10	52224-43C3	52224-43C4
	5MM	33CM	52255-43I	52255-43C1	52255-43C17	52255-43C18	52255-43C10	52255-43C3	52255-43C4
	5MM	36CM	52236-43I	52236-43C1	52236-43C17	52236-43C18	52236-43C10	52236-43C3	52236-43C4
	5MM	45CM	52155-43I	52155-43C1	52155-43C17	52155-43C18	52155-43C10	52155-43C3	52155-43C4
KOCHER GRASPER, 1 X 2 TEETH, DOUBLE- ACTION (WECK TYPE)  15MM JAW	5MM	24CM	52224-44I	52224-44C1	52224-44C17	52224-44C18	52224-44C10	52224-44C3	52224-44C4
	5MM	33CM	52255-44I	52255-44C1	52255-44C17	52255-44C18	52255-44C10	52255-44C3	52255-44C4
	5MM	36CM	52236-44I	52236-44C1	52236-44C17	52236-44C18	52236-44C10	52236-44C3	52236-44C4
	5MM	45CM	52155-44I	52155-44C1	52155-44C17	52155-44C18	52155-44C10	52155-44C3	52155-44C4
SCHROEDER TENACULUM, SINGLE TOOTH, ROUND TIP  25MM JAW	5MM	24CM	52224-45I	52224-45C1	52224-45C17	52224-45C18	52224-45C10	52224-45C3	52224-45C4
	5MM	33CM	52255-45I	52255-45C1	52255-45C17	52255-45C18	52255-45C10	52255-45C3	52255-45C4
	5MM	36CM	52236-45I	52236-45C1	52236-45C17	52236-45C18	52236-45C10	52236-45C3	52236-45C4
	5MM	45CM	52155-45I	52155-45C1	52155-45C17	52155-45C18	52155-45C10	52155-45C3	52155-45C4
	10MM	33CM	52102-45I	52102-45C1	52102-45C17	52102-45C18	52102-45C10	52102-45C3	52102-45C4
	10MM	36CM	52103-45I	52103-45C1	52103-45C17	52103-45C18	52103-45C10	52103-45C3	52103-45C4
SCHROEDER TENACULUM, SINGLE TOOTH, SQUARE TIP  25MM JAW	5MM	24CM	52224-145I	52224-145C1	52224-145C17	52224-145C18	52224-145C10	52224-145C3	52224-145C4
	5MM	33CM	52255-145I	52255-145C1	52255-145C17	52255-145C18	52255-145C10	52255-145C3	52255-145C4
	5MM	36CM	52236-145I	52236-145C1	52236-145C17	52236-145C18	52236-145C10	52236-145C3	52236-145C4
	5MM	45CM	52155-145I	52155-145C1	52155-145C17	52155-145C18	52155-145C10	52155-145C3	52155-145C4
SCHROEDER TENACULUM GRASPER, SINGLE TOOTH w/ EXTRA GUIDE TOOTH  25MM JAW	5MM	24CM	52224-94I	52224-94C1	52224-94C17	52224-94C18	52224-94C10	52224-94C3	52224-94C4
	5MM	33CM	52255-94I	52255-94C1	52255-94C17	52255-94C18	52255-94C10	52255-94C3	52255-94C4
	5MM	36CM	52236-94I	52236-94C1	52236-94C17	52236-94C18	52236-94C10	52236-94C3	52236-94C4
	5MM	45CM	52155-94I	52155-94C1	52155-94C17	52155-94C18	52155-94C10	52155-94C3	52155-94C4
	10MM	33CM	52102-94I	52102-94C1	52102-94C17	52102-94C18	52102-94C10	52102-94C3	52102-94C4
	10MM	36CM	52103-94I	52103-94C1	52103-94C17	52103-94C18	52103-94C10	52103-94C3	52103-94C4
BLUNT ATRAUMATIC GRASPING FORCEPS, DOUBLE-ACTION  14MM JAW	5MM	24CM	52224-47I	52224-47C1	52224-47C17	52224-47C18	52224-47C10	52224-47C3	52224-47C4
	5MM	33CM	52255-47I	52255-47C1	52255-47C17	52255-47C18	52255-47C10	52255-47C3	52255-47C4
	5MM	36CM	52236-47I	52236-47C1	52236-47C17	52236-47C18	52236-47C10	52236-47C3	52236-47C4
	5MM	45CM	52155-47I	52155-47C1	52155-47C17	52155-47C18	52155-47C10	52155-47C3	52155-47C4

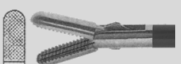
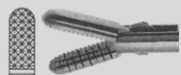

STYLE C:

ROTATABLE, THREE PIECE MODULAR INSTRUMENT

Dissectors & Graspers





TIP ID.	DIAMETER	LENGTH	INSERT NO.	52555-40-01	52555-40-17	52555-40-18	52555-40-10	52555-40-03	52555-40-04
				INSULATED & CARBON FIBER HANDLES				NON-INSULATED HANDLES	
BLUNT ATRAUMATIC GRASPER W/ CROSS-SERRATED TIPS, DBL-ACTION  14MM	5MM	24CM	52224-56I	52224-56C1	52224-56C17	52224-56C18	52224-56C10	52224-56C3	52224-56C4
	5MM	33CM	52255-56I	52255-56C1	52255-56C17	52255-56C18	52255-56C10	52255-56C3	52255-56C4
	5MM	36CM	52236-56I	52236-56C1	52236-56C17	52236-56C18	52236-56C10	52236-56C3	52236-56C4
	5MM	45CM	52155-56I	52155-56C1	52155-56C17	52155-56C18	52155-56C10	52155-56C3	52155-56C4
BULLET NOSE GRASPER TC, MICRO DIAMOND JAW PATTERN  15MM	5MM	24CM	52224-48I	52224-48C1	52224-48C17	52224-48C18	52224-48C10	52224-48C3	52224-48C4
	5MM	33CM	52255-48I	52255-48C1	52255-48C17	52255-48C18	52255-48C10	52255-48C3	52255-48C4
	5MM	36CM	52236-48I	52236-48C1	52236-48C17	52236-48C18	52236-48C10	52236-48C3	52236-48C4
	5MM	45CM	52155-48I	52155-48C1	52155-48C17	52155-48C18	52155-48C10	52155-48C3	52155-48C4
BULLET NOSE GRASPER, TC, CROSS DIAMOND JAW PATTERN  15MM JAW	5MM	24CM	52224-49I	52224-49C1	52224-49C17	52224-49C18	52224-49C10	52224-49C3	52224-49C4
	5MM	33CM	52255-49I	52255-49C1	52255-49C17	52255-49C18	52255-49C10	52255-49C3	52255-49C4
	5MM	36CM	52236-49I	52236-49C1	52236-49C17	52236-49C18	52236-49C10	52236-49C3	52236-49C4
	5MM	45CM	52155-49I	52155-49C1	52155-49C17	52155-49C18	52155-49C10	52155-49C3	52155-49C4
LONG TAPERED GRASPER W/ ATRAUMATIC TEETH  20MM JAW	5MM	24CM	52224-51I	52224-51C1	52224-51C17	52224-51C18	52224-51C10	52224-51C3	52224-51C4
	5MM	33CM	52255-51I	52255-51C1	52255-51C17	52255-51C18	52255-51C10	52255-51C3	52255-51C4
	5MM	36CM	52236-51I	52236-51C1	52236-51C17	52236-51C18	52236-51C10	52236-51C3	52236-51C4
	5MM	45CM	52155-51I	52155-51C1	52155-51C17	52155-51C18	52155-51C10	52155-51C3	52155-51C4
WAVE GRASPER, POINTED, SINGLE-ACTION  14MM JAW	5MM	24CM	52224-54I	52224-54C1	52224-54C17	52224-54C18	52224-54C10	52224-54C3	52224-54C4
	5MM	33CM	52255-54I	52255-54C1	52255-54C17	52255-54C18	52255-54C10	52255-54C3	52255-54C4
	5MM	36CM	52236-54I	52236-54C1	52236-54C17	52236-54C18	52236-54C10	52236-54C3	52236-54C4
	5MM	45CM	52155-54I	52155-54C1	52155-54C17	52155-54C18	52155-54C10	52155-54C3	52155-54C4
"DAVOL" TYPE, GRASPER, SCOOPED-OUT JAW & GENTLY MASHING TEETH  15MM JAW	5MM	24CM	52224-90I	52224-90C1	52224-90C17	52224-90C18	52224-90C10	52224-90C3	52224-90C4
	5MM	33CM	52255-90I	52255-90C1	52255-90C17	52255-90C18	52255-90C10	52255-90C3	52255-90C4
	5MM	36CM	52236-90I	52236-90C1	52236-90C17	52236-90C18	52236-90C10	52236-90C3	52236-90C4
	5MM	45CM	52155-90I	52155-90C1	52155-90C17	52155-90C18	52155-90C10	52155-90C3	52155-90C4

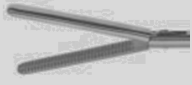

STYLE C:

ROTATABLE, THREE PIECE MODULAR INSTRUMENT

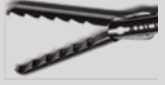
Dissectors & Graspers







TIP ID.	DIAMETER	LENGTH	INSERT NO.	52555-40-01	52555-40-17	52555-40-18	52555-40-10	52555-40-03	52555-40-04
				INSULATED & CARBON FIBER HANDLES				NON-INSULATED HANDLES	
 STRONG ATRAUMATIC CLAMP, 40MM STRAIGHT JAW 40MM JAW	10MM	33CM	52102-46I	52102-46C1	52102-46C17	52102-46C18	52102-46C10	52102-46C3	52102-46C4
	10MM	36CM	52103-46I	52103-46C1	52103-46C17	52103-46C18	52103-46C10	52103-46C3	52103-46C4
	10MM	45CM	52101-46I	52101-46C1	52101-46C17	52101-46C18	52101-46C10	52101-46C3	52101-46C4
 "STRONG ATRAUMATIC CLAMP, 40MM CURVED JAW 40MM JAW	10MM	33CM	52102-47I	52102-47C1	52102-47C17	52102-47C18	52102-47C10	52102-47C3	52102-47C4
	10MM	36CM	52103-47I	52103-47C1	52103-47C17	52103-47C18	52103-47C10	52103-47C3	52103-47C4
	10MM	45CM	52101-47I	52101-47C1	52101-47C17	52101-47C18	52101-47C10	52101-47C3	52101-47C4
 ANVIL GRASPER TO GRASP & HOLD ANVIL OF A CIRCULAR STAPLER 10MM JAW	10MM	33CM	52102-20I	52102-20C1	52102-20C17	52102-20C18	52102-20C10	52102-20C3	52102-20C4
	10MM	36CM	52103-20I	52103-20C1	52103-20C17	52103-20C18	52103-20C10	52103-20C3	52103-20C4
	10MM	45CM	52101-20I	52101-20C1	52101-20C17	52101-20C18	52101-20C10	52101-20C3	52101-20C4
 ALLIGATOR GRASPER, RETRO-FACING TEETH, 15MM	5MM	24CM	52224-129I	52224-129C1	52224-129C17	52224-129C18	52224-129C10	52224-129C3	52224-129C4
	5MM	33CM	52255-129I	52255-129C1	52255-129C17	52255-129C18	52255-129C10	52255-129C3	52255-129C4
	5MM	36CM	52236-129I	52236-129C1	52236-129C17	52236-129C18	52236-129C10	52236-129C3	52236-129C4
	5MM	45CM	52155-129I	52155-129C1	52155-129C17	52155-129C18	52155-129C10	52155-129C3	52155-129C4
 DEBAKEY GRASPER, 34MM JAW 34MM TIP	5MM	24CM	52224-122I	52224-122C1	52224-122C17	52224-122C18	52224-122C10	52224-122C3	52224-122C4
	5MM	33CM	52255-122I	52255-122C1	52255-122C17	52255-122C18	52255-122C10	52255-122C3	52255-122C4
	5MM	36CM	52236-122I	52236-122C1	52236-122C17	52236-122C18	52236-122C10	52236-122C3	52236-122C4
	5MM	45CM	52155-122I	52155-122C1	52155-122C17	52155-122C18	52155-122C10	52155-122C3	52155-122C4
 PADDLE BABCOCK GRASPER 30MM TIP	5MM	24CM	52224-216I	52224-216C1	52224-216C17	52224-216C18	52224-216C10	52224-216C3	52224-216C4
	5MM	33CM	52255-216I	52255-216C1	52255-216C17	52255-216C18	52255-216C10	52255-216C3	52255-216C4
	5MM	36CM	52236-216I	52236-216C1	52236-216C17	52236-216C18	52236-216C10	52236-216C3	52236-216C4
	5MM	45CM	52155-216I	52155-216C1	52155-216C17	52155-216C18	52155-216C10	52155-216C3	52155-216C4



STYLE C:

ROTATABLE, THREE PIECE MODULAR INSTRUMENT

Forceps & Scissors













TIP ID.	DIAMETER	LENGTH	INSERT NO.	52555-40-01	52555-40-17	52555-40-18	52555-40-10	52555-40-03	52555-40-15
				INSULATED & CARBON FIBER HANDLES				NON-INSULATED HANDLES	
 HOOK SCISSORS, SINGLE-ACTION 10MM JAW	5MM	24CM	52224-60I	52224-60C1	52224-60C17	52224-60C18	52224-60C10	52224-60C3	52224-60C15
	5MM	33CM	52255-60I	52255-60C1	52255-60C17	52255-60C18	52255-60C10	52255-60C3	52255-60C15
	5MM	36CM	52236-60I	52236-60C1	52236-60C17	52236-60C18	52236-60C10	52236-60C3	52236-60C15
	5MM	45CM	52155-60I	52155-60C1	52155-60C17	52155-60C18	52155-60C10	52155-60C3	52155-60C15
 MICRO TIP SCISSORS, STRAIGHT, SINGLE-ACTION 5MM JAW	5MM	24CM	52224-61I	52224-61C1	52224-61C17	52224-61C18	52224-61C10	52224-61C3	52224-61C15
	5MM	33CM	52255-61I	52255-61C1	52255-61C17	52255-61C18	52255-61C10	52255-61C3	52255-61C15
	5MM	36CM	52236-61I	52236-61C1	52236-61C17	52236-61C18	52236-61C10	52236-61C3	52236-61C15
	5MM	45CM	52155-61I	52155-61C1	52155-61C17	52155-61C18	52155-61C10	52155-61C3	52155-61C15
 MICRO TIP SCISSORS, CURVED, SINGLE-ACTION 5MM JAW	5MM	24CM	52224-62I	52224-62C1	52224-62C17	52224-62C18	52224-62C10	52224-62C3	52224-62C15
	5MM	33CM	52255-62I	52255-62C1	52255-62C17	52255-62C18	52255-62C10	52255-62C3	52255-62C15
	5MM	36CM	52236-62I	52236-62C1	52236-62C17	52236-62C18	52236-62C10	52236-62C3	52236-62C15
	5MM	45CM	52155-62I	52155-62C1	52155-62C17	52155-62C18	52155-62C10	52155-62C3	52155-62C15
 METZENBAUM SCISSORS, STRAIGHT, LONG BLADE (20MM) 20MM JAW	5MM	24CM	52224-63I	52224-63C1	52224-63C17	52224-63C18	52224-63C10	52224-63C3	52224-63C15
	5MM	33CM	52255-63I	52255-63C1	52255-63C17	52255-63C18	52255-63C10	52255-63C3	52255-63C15
	5MM	36CM	52236-63I	52236-63C1	52236-63C17	52236-63C18	52236-63C10	52236-63C3	52236-63C15
	5MM	45CM	52155-63I	52155-63C1	52155-63C17	52155-63C18	52155-63C10	52155-63C3	52155-63C15
 METZENBAUM SCISSORS, STRAIGHT, SHORT BLADE (12MM) 12MM JAW	5MM	24CM	52224-64I	52224-64C1	52224-64C17	52224-64C18	52224-64C10	52224-64C3	52224-64C15
	5MM	33CM	52255-64I	52255-64C1	52255-64C17	52255-64C18	52255-64C10	52255-64C3	52255-64C15
	5MM	36CM	52236-64I	52236-64C1	52236-64C17	52236-64C18	52236-64C10	52236-64C3	52236-64C15
	5MM	45CM	52155-64I	52155-64C1	52155-64C17	52155-64C18	52155-64C10	52155-64C3	52155-64C15
 METZENBAUM SCISSORS, CURVED, LONG BLADE (16MM) 16MM JAW	5MM	24CM	52224-65I	52224-65C1	52224-65C17	52224-65C18	52224-65C10	52224-65C3	52224-65C15
	5MM	33CM	52255-65I	52255-65C1	52255-65C17	52255-65C18	52255-65C10	52255-65C3	52255-65C15
	5MM	36CM	52236-65I	52236-65C1	52236-65C17	52236-65C18	52236-65C10	52236-65C3	52236-65C15
	5MM	45CM	52155-65I	52155-65C1	52155-65C17	52155-65C18	52155-65C10	52155-65C3	52155-65C15

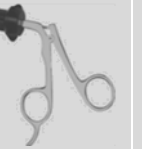

STYLE C:

ROTATABLE, THREE PIECE MODULAR INSTRUMENT

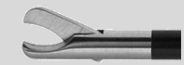
Forceps & Scissors





TIP ID.	DIAMETER	LENGTH	INSERT NO.	52555-40-01	52555-40-17	52555-40-18	52555-40-10	52555-40-03	52555-40-15
									
				INSULATED & CARBON FIBER HANDLES				NON-INSULATED HANDLES	
METZENBAUM SCISSORS, HARDENED STEEL, CURVED BLADE (16MM TIP)  16MM JAW	5MM	24CM	52224-165I	52224-165C1	52224-165C17	52224-165C18	52224-165C10	52224-165C3	52224-165C15
	5MM	33CM	52255-165I	52255-165C1	52255-165C17	52255-165C18	52255-165C10	52255-165C3	52255-165C15
	5MM	36CM	52236-165I	52236-165C1	52236-165C17	52236-165C18	52236-165C10	52236-165C3	52236-165C15
	5MM	45CM	52155-165I	52155-165C1	52155-165C17	52155-165C18	52155-165C10	52155-165C3	52155-165C15
METZENBAUM SCISSORS, WONDER- CUT , CURVED BLADE (20MM TIP)  20MM JAW	5MM	24CM	52224-265I	52224-265C1	52224-265C17	52224-265C18	52224-265C10	52224-265C3	52224-265C15
	5MM	33CM	52255-265I	52255-265C1	52255-265C17	52255-265C18	52255-265C10	52255-265C3	52255-265C15
	5MM	36CM	52236-265I	52236-265C1	52236-265C17	52236-265C18	52236-265C10	52236-265C3	52236-265C15
	5MM	45CM	52155-265I	52155-265C1	52155-265C17	52155-265C18	52155-265C10	52155-265C3	52155-265C15
METZENBAUM SCISSORS, CURVED, SHORT BLADE (12MM)  12MM JAW	5MM	24CM	52224-166I	52224-166C1	52224-166C17	52224-166C18	52224-166C10	52224-166C3	52224-166C15
	5MM	33CM	52255-166I	52255-166C1	52255-166C17	52255-166C18	52255-166C10	52255-166C3	52255-166C15
	5MM	36CM	52236-166I	52236-166C1	52236-166C17	52236-166C18	52236-166C10	52236-166C3	52236-166C15
	5MM	45CM	52155-166I	52155-166C1	52155-166C17	52155-166C18	52155-166C10	52155-166C3	52155-166C15
PERITONEAL SCISSORS, SINGLE-ACTION  15MM JAW	5MM	24CM	52224-67I	52224-67C1	52224-67C17	52224-67C18	52224-67C10	52224-67C3	52224-67C15
	5MM	33CM	52255-67I	52255-67C1	52255-67C17	52255-67C18	52255-67C10	52255-67C3	52255-67C15
	5MM	36CM	52236-67I	52236-67C1	52236-67C17	52236-67C18	52236-67C10	52236-67C3	52236-67C15
	5MM	45CM	52155-67I	52155-67C1	52155-67C17	52155-67C18	52155-67C10	52155-67C3	52155-67C15
HOOK SCISSORS, TS, EXTRA HARD STEEL  10MM JAW	5MM	24CM	52224-76I	52224-76C1	52224-76C17	52224-76C18	52224-76C10	52224-76C3	52224-76C15
	5MM	33CM	52255-76I	52255-76C1	52255-76C17	52255-76C18	52255-76C10	52255-76C3	52255-76C15
	5MM	36CM	52236-76I	52236-76C1	52236-76C17	52236-76C18	52236-76C10	52236-76C3	52236-76C15
	5MM	45CM	52155-76I	52155-76C1	52155-76C17	52155-76C18	52155-76C10	52155-76C3	52155-76C15
PERITONEAL SCISSORS, TS, EXTRA HARD STEEL, SINGLE-ACTION  15MM JAW	5MM	24CM	52224-77I	52224-77C1	52224-77C17	52224-77C18	52224-77C10	52224-77C3	52224-77C15
	5MM	33CM	52255-77I	52255-77C1	52255-77C17	52255-77C18	52255-77C10	52255-77C3	52255-77C15
	5MM	36CM	52236-77I	52236-77C1	52236-77C17	52236-77C18	52236-77C10	52236-77C3	52236-77C15
	5MM	45CM	52155-77I	52155-77C1	52155-77C17	52155-77C18	52155-77C10	52155-77C3	52155-77C15

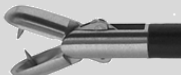

STYLE C:

ROTATABLE, THREE PIECE MODULAR INSTRUMENT

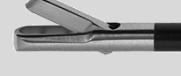
Forceps & Scissors

TIP ID.	DIAMETER	LENGTH	INSERT NO.	52555-40-01	52555-40-17	52555-40-18	52555-40-10	52555-40-03	52555-40-15
				INSULATED & CARBON FIBER HANDLES				NON-INSULATED HANDLES	
BIOPSY SPOON FORCEPS, DOUBLE-ACTION  10MM JAW	5MM	24CM	52224-70I	52224-70C1	52224-70C17	52224-70C18	52224-70C10	52224-70C3	52224-70C15
	5MM	33CM	52255-70I	52255-70C1	52255-70C17	52255-70C18	52255-70C10	52255-70C3	52255-70C15
	5MM	36CM	52236-70I	52236-70C1	52236-70C17	52236-70C18	52236-70C10	52236-70C3	52236-70C15
	5MM	45CM	52155-70I	52155-70C1	52155-70C17	52155-70C18	52155-70C10	52155-70C3	52155-70C15
BIOPSY SPOON-FORCEPS, W/ TOOTH (SEMM-TYPE), D/A  10MM JAW	5MM	24CM	52224-68I	52224-68C1	52224-68C17	52224-68C18	52224-68C10	52224-68C3	52224-68C15
	5MM	33CM	52255-68I	52255-68C1	52255-68C17	52255-68C18	52255-68C10	52255-68C3	52255-68C15
	5MM	36CM	52236-68I	52236-68C1	52236-68C17	52236-68C18	52236-68C10	52236-68C3	52236-68C15
	5MM	45CM	52155-68I	52155-68C1	52155-68C17	52155-68C18	52155-68C10	52155-68C3	52155-68C15
BIOPSY PUNCH, SINGLE-ACTION  10MM JAW	5MM	24CM	52224-71I	52224-71C1	52224-71C17	52224-71C18	52224-71C10	52224-71C3	52224-71C15
	5MM	33CM	52255-71I	52255-71C1	52255-71C17	52255-71C18	52255-71C10	52255-71C3	52255-71C15
	5MM	36CM	52236-71I	52236-71C1	52236-71C17	52236-71C18	52236-71C10	52236-71C3	52236-71C15
	5MM	45CM	52155-71I	52155-71C1	52155-71C17	52155-71C18	52155-71C10	52155-71C3	52155-71C15
BIOPSY PUNCH WITH TOOTH, SINGLE-ACTION  10MM JAW	5MM	24CM	52224-72I	52224-72C1	52224-72C17	52224-72C18	52224-72C10	52224-72C3	52224-72C15
	5MM	33CM	52255-72I	52255-72C1	52255-72C17	52255-72C18	52255-72C10	52255-72C3	52255-72C15
	5MM	36CM	52236-72I	52236-72C1	52236-72C17	52236-72C18	52236-72C10	52236-72C3	52236-72C15
	5MM	45CM	52155-72I	52155-72C1	52155-72C17	52155-72C18	52155-72C10	52155-72C3	52155-72C15
BIOPSY PUNCH, SINGLE-ACTION  10MM JAW	5MM	24CM	52224-73I	52224-73C1	52224-73C17	52224-73C18	52224-73C10	52224-73C3	52224-73C15
	5MM	33CM	52255-73I	52255-73C1	52255-73C17	52255-73C18	52255-73C10	52255-73C3	52255-73C15
	5MM	36CM	52236-73I	52236-73C1	52236-73C17	52236-73C18	52236-73C10	52236-73C3	52236-73C15
	5MM	45CM	52155-73I	52155-73C1	52155-73C17	52155-73C18	52155-73C10	52155-73C3	52155-79C15
POINTED BIOPSY SPOON FORCEPS, SINGLE ACTION  10MM TIP	5MM	24CM	52224-305I	52224-305C1	52224-305C17	52224-305C18	52224-305C10	52224-305C3	52224-305C4
	5MM	33CM	52255-305I	52255-305C1	52255-305C17	52255-305C18	52255-305C10	52255-305C3	52255-305C4
	5MM	36CM	52236-305I	52236-305C1	52236-305C17	52236-305C18	52236-305C10	52236-305C3	52236-305C4
	5MM	45CM	52155-305I	52155-305C1	52155-305C17	52155-305C18	52155-305C10	52155-305C3	52155-305C4

Sure-Grip Slide-Lock

The *Sure-Grip* 5mm & 10mm Graspers have **Positive, Precise Action For Sure-Grip Grasping & Retraction.**



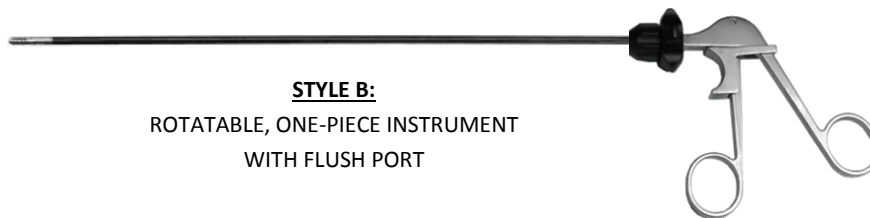
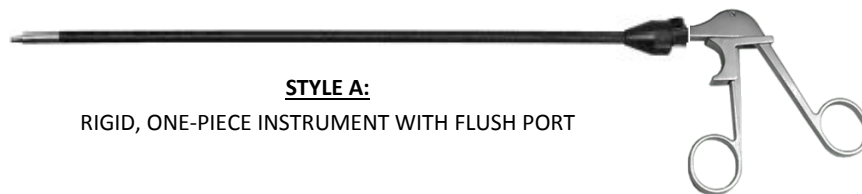



Available in One-Piece Rigid, One-Piece Rotatable & Three-Piece Screw Apart Instruments

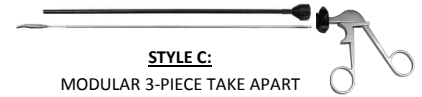
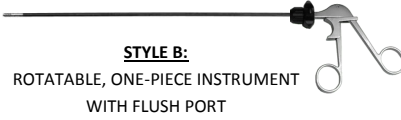

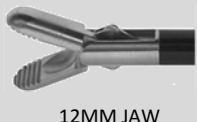

Graspers

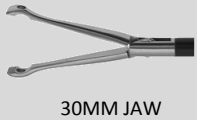

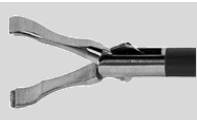





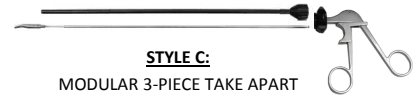
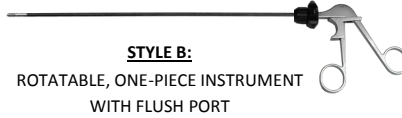
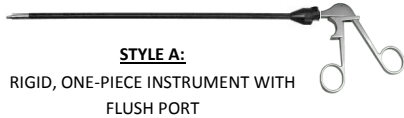

TIP ID.	DESCRIPTION	DIAMETER	LENGTH	INSERT NO.	STYLE A	STYLE B	STYLE C
 12MM JAW	STANDARD GRASPER W/ SPOON	5MM	24CM	52224-02I	52624-02A	52624-02B	52624-02C
		5MM	33CM	52255-02I	52605-02A	52605-02B	52605-02C
		5MM	36CM	52236-02I	52636-02A	52636-02B	52636-02C
		5MM	45CM	52155-02I	52615-02A	52615-02B	52615-02C
 12MM JAW	STANDARD GRASPER	5MM	24CM	52224-03I	52624-03A	52624-03B	52624-03C
		5MM	33CM	52255-03I	52605-03A	52605-03B	52605-03C
		5MM	36CM	52236-03I	52636-03A	52636-03B	52636-03C
		5MM	45CM	52155-03I	52615-03A	52615-03B	52615-03C
 15MM JAW	TAPERED DOLPHIN-NOSE	5MM	24CM	52224-05I	52624-05A	52624-05B	52624-05C
		5MM	33CM	52255-05I	52605-05A	52605-05B	52605-05C
		5MM	36CM	52236-05I	52636-05A	52636-05B	52636-05C
		5MM	45CM	52155-05I	52615-05A	52615-05B	52615-05C
 12MM JAW	TAPERED DOLPHIN-NOSE W/ SPOON	5MM	24CM	52224-105I	52624-105A	52624-105B	52624-105C
		5MM	33CM	52255-105I	52605-105A	52605-105B	52605-105C
		5MM	36CM	52236-105I	52636-105A	52636-105B	52636-105C
		5MM	45CM	52155-105I	52615-105A	52615-105B	52615-105C
 10MM JAW	COBRA GRASPER, DOUBLE-ACTION	5MM	24CM	52224-15I	52624-15A	52624-15B	52624-15C
		5MM	33CM	52255-15I	52605-15A	52605-15B	52605-15C
		5MM	36CM	52236-15I	52636-15A	52636-15B	52636-15C
		5MM	45CM	52155-15I	52615-15A	52615-15B	52615-15C
 30MM JAW	BABCOCK GRASPER, FENESTRATED TIP	5MM	24CM	52224-16I	52624-16A	52624-16B	52624-16C
		5MM	33CM	52255-16I	52605-16A	52605-16B	52605-16C
		5MM	36CM	52236-16I	52636-16A	52636-16B	52636-16C
		5MM	45CM	52155-16I	52615-16A	52615-16B	52615-16C
 30MM JAW	BABCOCK GRASPER, AXIS STYLE, FENESTRATED	5MM	24CM	52224-116I	52624-116A	52624-116B	52624-116C
		5MM	33CM	52255-116I	52605-116A	52605-116B	52605-116C
		5MM	36CM	52236-116I	52636-116A	52636-116B	52636-116C
		5MM	45CM	52155-116I	52615-116A	52615-116B	52615-116C
 10MM JAW	BABCOCK GRASPER, SHORT DELICATE	5MM	24CM	52224-17I	52624-17A	52624-17B	52624-17C
		5MM	33CM	52255-17I	52605-17A	52605-17B	52605-17C
		5MM	36CM	52236-17I	52636-17A	52636-17B	52636-17C
		5MM	45CM	52155-17I	52615-17A	52615-17B	52615-17C



Graspers







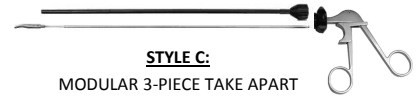
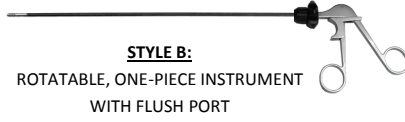
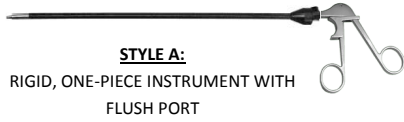

TIP ID.	DESCRIPTION	DIAMETER	LENGTH	INSERT NO.	STYLE A	STYLE B	STYLE C
 15MM JAW	ALLIS GRASPER, SHORT VERSION, SA	5MM	24CM	52224-18I	52624-18A	52624-18B	52624-18C
		5MM	33CM	52255-18I	52605-18A	52605-18B	52605-18C
		5MM	36CM	52236-18I	52636-18A	52636-18B	52636-18C
		5MM	45CM	52155-18I	52615-18A	52615-18B	52615-18C
 12MM JAW	ALLIS, SHORT VERSION, 3 X 4 TEETH, SERRATED	5MM	24CM	52224-19I	52624-19A	52624-19B	52624-19C
		5MM	33CM	52255-19I	52605-19A	52605-19B	52605-19C
		5MM	36CM	52236-19I	52636-19A	52636-19B	52636-19C
		5MM	45CM	52155-19I	52615-19A	52615-19B	52615-19C
 12MM JAW	ALLIS, SHORT VERSION, DOUBLE ROW OF TEETH, SERRATED	5MM	24CM	52224-119I	52624-119A	52624-119B	52624-119C
		5MM	33CM	52255-119I	52605-119A	52605-119B	52605-119C
		5MM	36CM	52236-119I	52636-119A	52636-119B	52636-119C
		5MM	45CM	52155-119I	52615-119A	52615-119B	52615-119C
 25MM JAW	ALLIS, LONG VERSION, DOUBLE ROW OF TEETH, SERRATED	5MM	24CM	52224-219I	52624-219A	52624-219B	52624-219C
		5MM	33CM	52255-219I	52605-219A	52605-219B	52605-219C
		5MM	36CM	52236-219I	52636-219A	52636-219B	52636-219C
		5MM	45CM	52155-219I	52615-219A	52615-219B	52615-219C
 20MM JAW	ALLIS GRASPER, MEDIUM, WECK STYLE	5MM	24CM	52224-20I	52624-20A	52624-20B	52624-20C
		5MM	33CM	52255-20I	52605-20A	52605-20B	52605-20C
		5MM	36CM	52236-20I	52636-20A	52636-20B	52636-20C
		5MM	45CM	52155-20I	52615-20A	52615-20B	52615-20C
 30MM JAW	ALLIS GRASPER, STANDARD VERSION	5MM	24CM	52224-21I	52624-21A	52624-21B	52624-21C
		5MM	33CM	52255-21I	52605-21A	52605-21B	52605-21C
		5MM	36CM	52236-21I	52636-21A	52636-21B	52636-21C
		5MM	45CM	52155-21I	52615-21A	52615-21B	52615-21C
 35MM JAW	ALLIS GRASPER, TC, STANDARD VERSION	5MM	24CM	52224-57I	52624-57A	52624-57B	52624-57C
		5MM	33CM	52255-57I	52605-57A	52605-57B	52605-57C
		5MM	36CM	52236-57I	52636-57A	52636-57B	52636-57C
		5MM	45CM	52155-57I	52615-57A	52615-57B	52615-57C
 20MM JAW	DEBAKEY GRASPER, 20MM JAW	5MM	24CM	52224-22I	52624-22A	52624-22B	52624-22C
		5MM	33CM	52255-22I	52605-22A	52605-22B	52605-22C
		5MM	36CM	52236-22I	52636-22A	52636-22B	52636-22C
		5MM	45CM	52155-22I	52615-22A	52615-22B	52615-22C



Graspers

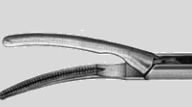

TIP ID.	DESCRIPTION	DIAMETER	LENGTH	INSERT NO.	STYLE A	STYLE B	STYLE C
 40MM JAW	DEBAKEY GRASPER, 40MM JAW	5MM	24CM	52224-23I	52624-23A	52624-23B	52624-23C
		5MM	33CM	52255-23I	52605-23A	52605-23B	52605-23C
		5MM	36CM	52236-23I	52636-23A	52636-23B	52636-23C
		5MM	45CM	52155-23I	52615-23A	52615-23B	52615-23C
 60MM JAW	DEBAKEY GRASPER, 60MM JAW	5MM	24CM	52224-123I	52624-123A	52624-123B	52624-123C
		5MM	33CM	52255-123I	52605-123A	52605-123B	52605-123C
		5MM	36CM	52236-123I	52636-123A	52636-123B	52636-123C
		5MM	45CM	52155-123I	52615-123A	52615-123B	52615-123C
 20MM JAW	HUNTER DEBAKEY, FENESTRATED, 20MM	5MM	24CM	52224-58I	52624-58A	52624-58B	52624-58C
		5MM	33CM	52255-58I	52605-58A	52605-58B	52605-58C
		5MM	36CM	52236-58I	52636-58A	52636-58B	52636-58C
		5MM	45CM	52155-58I	52615-58A	52615-58B	52615-58C
 40MM JAW	HUNTER DEBAKEY, FENESTRATED, 40MM	5MM	24CM	52224-159I	52624-159A	52624-159B	52624-159C
		5MM	33CM	52255-159I	52605-159A	52605-159B	52605-159C
		5MM	36CM	52236-159I	52636-159A	52636-159B	52636-159C
		5MM	45CM	52155-159I	52615-159A	52615-159B	52615-159C
 60MM JAW	HUNTER DEBAKEY, FENESTRATED, 60MM	5MM	24CM	52224-160I	52624-160A	52624-160B	52624-160C
		5MM	33CM	52255-160I	52605-160A	52605-160B	52605-160C
		5MM	36CM	52236-160I	52636-160A	52636-160B	52636-160C
		5MM	45CM	52155-160I	52615-160A	52615-160B	52615-160C
 30MM JAW	DEBAKEY GRASPER, CURVED	5MM	24CM	52224-46I	52624-46A	52624-46B	52624-46C
		5MM	33CM	52255-46I	52605-46A	52605-46B	52605-46C
		5MM	36CM	52236-46I	52636-46A	52636-46B	52636-46C
		5MM	45CM	52155-46I	52615-46A	52615-46B	52615-46C
 35MM JAW	DEBAKEY MARYLAND GRASPER	5MM	24CM	52224-149I	52624-149A	52624-149B	52624-149C
		5MM	33CM	52255-149I	52605-149A	52605-149B	52605-149C
		5MM	36CM	52236-149I	52636-149A	52636-149B	52636-149C
		5MM	45CM	52155-149I	52615-149A	52615-149B	52615-149C
 30MM JAW	GLASSMAN ATRAUMATIC GRASPER	5MM	24CM	52224-24I	52624-24A	52624-24B	52624-24C
		5MM	33CM	52255-24I	52605-24A	52605-24B	52605-24C
		5MM	36CM	52236-24I	52636-24A	52636-24B	52636-24C
		5MM	45CM	52155-24I	52615-24A	52615-24B	52615-24C



Graspers

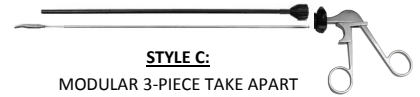
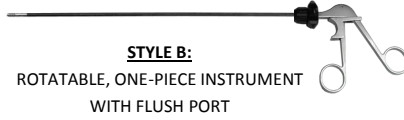
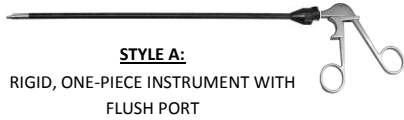





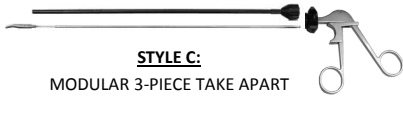
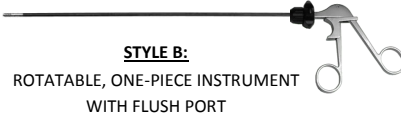
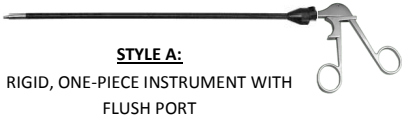

TIP ID.	DESCRIPTION	DIAMETER	LENGTH	INSERT NO.	STYLE A	STYLE B	STYLE C
16MM JAW	DOUBLE CUP FUNDUS MAXI GRASPER	5MM	24CM	52224-26I	52624-26A	52624-26B	52624-26C
		5MM	33CM	52255-26I	52605-26A	52605-26B	52605-26C
		5MM	36CM	52236-26I	52636-26A	52636-26B	52636-26C
		5MM	45CM	52155-26I	52615-26A	52615-26B	52615-26C
16MM JAW	"WINER" STYLE FUNDUS GRASPER	5MM	24CM	52224-326I	52624-326A	52624-326B	52624-326C
		5MM	33CM	52255-326I	52605-326A	52605-326B	52605-326C
		5MM	36CM	52236-326I	52636-326A	52636-326B	52636-326C
		5MM	45CM	52155-326I	52615-326A	52615-326B	52615-326C
16MM JAW	"MCKEARNAN" STYLE FUNDUS GRASPER	5MM	24CM	52224-126I	52624-126A	52624-126B	52624-126C
		5MM	33CM	52255-126I	52605-126A	52605-126B	52605-126C
		5MM	36CM	52236-126I	52636-126A	52636-126B	52636-126C
		5MM	45CM	52155-126I	52615-126A	52615-126B	52615-126C
16MM JAW	FENESTRATED DOUBLE FUNDUS GRASPER	5MM	24CM	52224-226I	52624-226A	52624-226B	52624-226C
		5MM	33CM	52255-226I	52605-226A	52605-226B	52605-226C
		5MM	36CM	52236-226I	52636-226A	52636-226B	52636-226C
		5MM	45CM	52155-226I	52615-226A	52615-226B	52615-226C
20MM JAW	ENDOCLINCH FENESTRATED GRASPER	5MM	24CM	52224-27I	52624-27A	52624-27B	52624-27C
		5MM	33CM	52255-27I	52605-27A	52605-27B	52605-27C
		5MM	36CM	52236-27I	52636-27A	52636-27B	52636-27C
		5MM	45CM	52155-27I	52615-27A	52615-27B	52615-27C
10MM JAW	ALLIGATOR GRASPER, RETRO-FACING TEETH, 10MM JAW	5MM	24CM	52224-29I	52624-29A	52624-29B	52624-29C
		5MM	33CM	52255-29I	52605-29A	52605-29B	52605-29C
		5MM	36CM	52236-29I	52636-29A	52636-29B	52636-29C
		5MM	45CM	52155-29I	52615-29A	52615-29B	52615-29C
15MM JAW	ALLIGATOR GRASPER, RETRO-FACING TEETH, 15MM JAW	5MM	24CM	52224-129I	52624-129A	52624-129B	52624-129C
		5MM	33CM	52255-129I	52605-129A	52605-129B	52605-129C
		5MM	36CM	52236-129I	52636-129A	52636-129B	52636-129C
		5MM	45CM	52155-129I	52615-129A	52615-129B	52615-129C
15MM JAW	GLASSMAN ATRAUMATIC GRASPER	5MM	24CM	52224-30I	52624-30A	52624-30B	52624-30C
		5MM	33CM	52255-30I	52605-30A	52605-30B	52605-30C
		5MM	36CM	52236-30I	52636-30A	52636-30B	52636-30C
		5MM	45CM	52155-30I	52615-30A	52615-30B	52615-30C

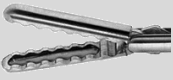
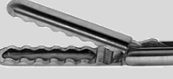

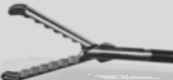
Graspers



TIP ID.	DESCRIPTION	DIAMETER	LENGTH	INSERT NO.	STYLE A	STYLE B	STYLE C
 22MM JAW	WAVE GRASPER, LONG BEVELED EDGE, DOUBLE ACTION	5MM	24CM	52224-32I	52624-32A	52624-32B	52624-32C
		5MM	33CM	52255-32I	52605-32A	52605-32B	52605-32C
		5MM	36CM	52236-32I	52636-32A	52636-32B	52636-32C
		5MM	45CM	52155-32I	52615-32A	52615-32B	52615-32C
 22MM JAW	WAVE GRASPER, LONG BEVELED EDGE, SINGLE ACTION	5MM	24CM	52224-33I	52624-33A	52624-33B	52624-33C
		5MM	33CM	52255-33I	52605-33A	52605-33B	52605-33C
		5MM	36CM	52236-33I	52636-33A	52636-33B	52636-33C
		5MM	45CM	52155-33I	52615-33A	52615-33B	52615-33C
 20MM JAW	CLAW GRASPER, 2 X 3 TEETH, SINGLE ACTION	5MM	24CM	52224-36I	52624-36A	52624-36B	52624-36C
		5MM	33CM	52255-36I	52605-36A	52605-36B	52605-36C
		5MM	36CM	52236-36I	52636-36A	52636-36B	52636-36C
		5MM	45CM	52155-36I	52615-36A	52615-36B	52615-36C
 20MM JAW	CLAW GRASPER, 2 X 3 TEETH, W/ XTRA ROW OF TEETH	5MM	24CM	52224-136I	52624-136A	52624-136B	52624-136C
		5MM	33CM	52255-136I	52605-136A	52605-136B	52605-136C
		5MM	36CM	52236-136I	52636-136A	52636-136B	52636-136C
		5MM	45CM	52155-136I	52615-136A	52615-136B	52615-136C
 20MM JAW	RETRACTION GRASPER, 2 X 3 TEETH, COBRA STYLE, DA	5MM	24CM	52224-34I	52624-34A	52624-34B	52624-34C
		5MM	33CM	52255-34I	52605-34A	52605-34B	52605-34C
		5MM	36CM	52236-34I	52636-34A	52636-34B	52636-34C
		5MM	45CM	52155-34I	52615-34A	52615-34B	52615-34C
 20MM JAW	RETRACTION GRASPER, 2 X 3 TEETH, COBRA STYLE, SA	5MM	24CM	52224-35I	52624-35A	52624-35B	52624-35C
		5MM	33CM	52255-35I	52605-35A	52605-35B	52605-35C
		5MM	36CM	52236-35I	52636-35A	52636-35B	52636-35C
		5MM	45CM	52155-35I	52615-35A	52615-35B	52615-35C
 20MM JAW	RETRACTION GRASPER, 2 X 3 TEETH, JARIT STYLE, DA	5MM	24CM	52224-134I	52624-134A	52624-134B	52624-134C
		5MM	33CM	52255-134I	52605-134A	52605-134B	52605-134C
		5MM	36CM	52236-134I	52636-134A	52636-134B	52636-134C
		5MM	45CM	52155-134I	52615-134A	52615-134B	52615-134C
 20MM JAW	RETRACTION GRASPER, 2 X 3 TEETH, JARIT STYLE, SA	5MM	24CM	52224-135I	52624-135A	52624-135B	52624-135C
		5MM	33CM	52255-135I	52605-135A	52605-135B	52605-135C
		5MM	36CM	52236-135I	52636-135A	52636-135B	52636-135C
		5MM	45CM	52155-135I	52615-135A	52615-135B	52615-135C



Graspers

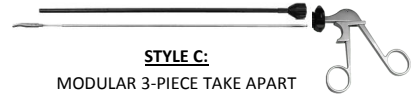
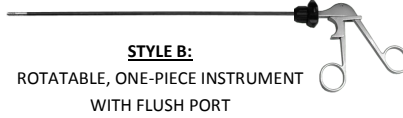
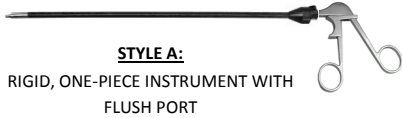

TIP ID.	DESCRIPTION	DIAMETER	LENGTH	INSERT NO.	STYLE A	STYLE B	STYLE C
16MM JAW	FENESTRATED GRASPER, 16MM JAW	5MM	24CM	52224-38I	52624-38A	52624-38B	52624-38C
		5MM	33CM	52255-38I	52605-38A	52605-38B	52605-38C
		5MM	36CM	52236-38I	52636-38A	52636-38B	52636-38C
		5MM	45CM	52155-38I	52615-38A	52615-38B	52615-38C
22MM JAW	FENESTRATED GRASPER, 20MM JAW	5MM	24CM	52224-39I	52624-39A	52624-39B	52624-39C
		5MM	33CM	52255-39I	52605-39A	52605-39B	52605-39C
		5MM	36CM	52236-39I	52636-39A	52636-39B	52636-39C
		5MM	45CM	52155-39I	52615-39A	52615-39B	52615-39C
40MM JAW	FENESTRATED GRASPER, 40MM JAW	5MM	24CM	52224-40I	52624-40A	52624-40B	52624-40C
		5MM	33CM	52255-40I	52605-40A	52605-40B	52605-40C
		5MM	36CM	52236-40I	52636-40A	52636-40B	52636-40C
		5MM	45CM	52155-40I	52615-40A	52615-40B	52615-40C
20MM JAW	JOHAN FENESTRATED GRASPER, 20MM TIP, SINGLE ACTION	5MM	24CM	52224-41I	52624-41A	52624-41B	52624-41C
		5MM	33CM	52255-41I	52605-41A	52605-41B	52605-41C
		5MM	36CM	52236-41I	52636-41A	52636-41B	52636-41C
		5MM	45CM	52155-41I	52615-41A	52615-41B	52615-41C
45MM JAW	JOHAN FENESTRATED GRASPER, 45MM TIP, SINGLE ACTION	5MM	24CM	52224-42I	52624-42A	52624-42B	52624-42C
		5MM	33CM	52255-42I	52605-42A	52605-42B	52605-42C
		5MM	36CM	52236-42I	52636-42A	52636-42B	52636-42C
		5MM	45CM	52155-42I	52615-42A	52615-42B	52615-42C
25MM JAW	DOUBLE FENESTRATED GRASPER, 25MM JAW	5MM	24CM	52224-139I	52624-139A	52624-139B	52624-139C
		5MM	33CM	52255-139I	52605-139A	52605-139B	52605-139C
		5MM	36CM	52236-139I	52636-139A	52636-139B	52636-139C
		5MM	45CM	52155-139I	52615-139A	52615-139B	52615-139C
25MM JAW	SCHROEDER TENACULUM, SINGLE TOOTH, ROUND TIP	5MM	24CM	52224-45I	52624-45A	52624-45B	52624-45C
		5MM	33CM	52255-45I	52605-45A	52605-45B	52605-45C
		5MM	36CM	52236-45I	52636-45A	52636-45B	52636-45C
		5MM	45CM	52155-134I	52615-134A	52615-134B	52615-134C
25MM JAW	SCHROEDER TENACULUM, SINGLE TOOTH, SQUARE TIP	5MM	24CM	52224-145I	52624-145A	52624-145B	52624-145C
		5MM	33CM	52255-145I	52605-145A	52605-145B	52605-145C
		5MM	36CM	52236-145I	52636-145A	52636-145B	52636-145C
		5MM	45CM	52155-145I	52615-145A	52615-145B	52615-145C





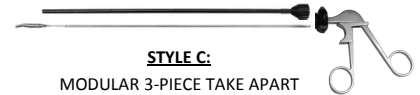









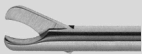

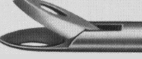
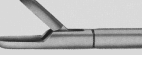
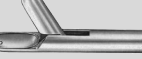

Graspers



TIP ID.	DESCRIPTION	DIAMETER	LENGTH	INSERT NO.	STYLE A	STYLE B	STYLE C
 25MM JAW	SCHROEDER TENACULUM GRASPER, SINGLE TOOTH w/ EXTRA GUIDE TOOTH	5MM	24CM	52224-94I	52624-94A	52624-94B	52624-94C
		5MM	33CM	52255-94I	52605-94A	52605-94B	52605-94C
		5MM	36CM	52236-94I	52636-94A	52636-94B	52636-94C
		5MM	45CM	52155-94I	52615-94A	52615-94B	52615-94C
 15MM JAW	BULLET NOSE GRASPER TC, MI- CRO DIAMOND JAW PATTERN	5MM	24CM	52224-48I	52624-48A	52624-48B	52624-48C
		5MM	33CM	52255-48I	52605-48A	52605-48B	52605-48C
		5MM	36CM	52236-48I	52636-48A	52636-48B	52636-48C
		5MM	45CM	52155-48I	52615-48A	52615-48B	52615-48C
 15MM JAW	BULLET NOSE GRASPER, TC, CROSS DIAMOND JAW PATTERN	5MM	24CM	52224-49I	52624-49A	52624-49B	52624-49C
		5MM	33CM	52255-49I	52605-49A	52605-49B	52605-49C
		5MM	36CM	52236-49I	52636-49A	52636-49B	52636-49C
		5MM	45CM	52155-49I	52615-49A	52615-49B	52615-49C
 15MM JAW	DAVOL™ TYPE, GRASPER, SCOOPED-OUT JAW & GENTLY MASHING TEETH	5MM	24CM	52224-41I	52624-41A	52624-41B	52624-41C
		5MM	33CM	52255-41I	52605-41A	52605-41B	52605-41C
		5MM	36CM	52236-41I	52636-41A	52636-41B	52636-41C
		5MM	45CM	52155-41I	52615-41A	52615-41B	52615-41C
 20MM JAW	ACCESS™ TYPE, FENESTRATED GRASPER, 20MM JAW	5MM	24CM	52224-42I	52624-42A	52624-42B	52624-42C
		5MM	33CM	52255-42I	52605-42A	52605-42B	52605-42C
		5MM	36CM	52236-42I	52636-42A	52636-42B	52636-42C
		5MM	45CM	52155-42I	52615-42A	52615-42B	52615-42C





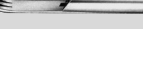



Traditional 5mm Laparoscopic Instruments

TIP ID.	DESCRIPTION	DIAMETER	LENGTH			
				STANDARD HANDLE	SPRING HANDLE	RATCHET HANDLE
	HOOK SCISSORS	5MM	33CM	52502-01A	52502-01B	52502-01C
		5MM	45CM	52501-01A	52501-01B	52501-01C
	PERITONEAL SCISSORS	5MM	33CM	52502-02A	52502-02B	52502-02C
		5MM	45CM	52501-02A	52501-02B	52501-02C
	SERRATED SCISSORS	5MM	33CM	52502-03A	52502-03B	52502-03C
		5MM	45CM	52501-03A	52501-03B	52501-03C
	METZENBAUM SCISSORS, CURVED	5MM	33CM	52502-04A	52502-04B	52502-04C
		5MM	45CM	52501-04A	52501-04B	52501-04C
	POINTED SPOON FORCEPS	5MM	33CM	52502-05A	52502-05B	52502-05C
		5MM	45CM	52501-05A	52501-05B	52501-05C
	SPOON FORCEPS	5MM	33CM	52502-06A	52502-06B	52502-06C
		5MM	45CM	52501-06A	52501-06B	52501-06C
	SPOON FORCEPS W/ TEETH	5MM	33CM	52502-07A	52502-07B	52502-07C
		5MM	45CM	52501-07A	52501-07B	52501-07C
	DOUBLE-ACTION SPOON FORCEPS	5MM	33CM	52502-08A	52502-08B	52502-08C
		5MM	45CM	52501-08A	52501-08B	52501-08C
	DBL-ACTION SPOON FORCEPS W/ TEETH	5MM	33CM	52502-09A	52502-09B	52502-09C
		5MM	45CM	52501-09A	52501-09B	52501-09C
	BIOPSY PUNCH FORCEPS	5MM	33CM	52502-10A	52502-10B	52502-10C
		5MM	45CM	52501-10A	52501-10B	52501-10C
	BIOPSY PUNCH W/ TEETH	5MM	33CM	52502-11A	52502-11B	52502-11C
		5MM	45CM	52501-11A	52501-11B	52501-11C
	HOOK PUNCH	5MM	33CM	52502-12A	52502-12B	52502-12C
		5MM	45CM	52501-12A	52501-12B	52501-12C
	STANDARD GRASPER W/ SPOON	5MM	33CM	52502-13A	52502-13B	52502-13C
		5MM	45CM	52501-13A	52501-13B	52501-13C
	POINTED GRASPER W/ SPOON	5MM	33CM	52502-14A	52502-14B	52502-14C
		5MM	45CM	52501-14A	52501-14B	52501-14C
	STANDARD GRASPER	5MM	33CM	52502-15A	52502-15B	52502-15C
		5MM	45CM	52501-15A	52501-15B	52501-15C
	BACKBITING GRASPER	5MM	33CM	52502-16A	52502-16B	52502-16C
		5MM	45CM	52501-16A	52501-16B	52501-16C
	ATRAUMATIC GRASPER	5MM	33CM	52502-17A	52502-17B	52502-17C
		5MM	45CM	52501-17A	52501-17B	52501-17C
	CLAW GRASPER	5MM	33CM	52502-18A	52502-18B	52502-18C
		5MM	45CM	52501-18A	52501-18B	52501-18C

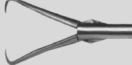

Traditional 5mm Laparoscopic Instruments

TIP ID.	DESCRIPTION	DIAMETER	LENGTH			
				STANDARD HANDLE	SPRING HANDLE	RATCHET HANDLE
	PETELIN DISSECTOR 60°	5MM	33CM	52502-19A	52502-19B	52502-19C
		5MM	45CM	52501-19A	52501-19B	52501-19C
	PETELIN DISSECTOR 30°	5MM	33CM	52502-20A	52502-20B	52502-20C
		5MM	45CM	52501-20A	52501-20B	52501-20C
	STRONG RIGHT ANGLE DISSECTOR	5MM	33CM	52502-31A	52502-31B	52502-31C
		5MM	45CM	52501-31A	52501-31B	52501-31C
	SPOON FOECEPS W/ TEETH	5MM	33CM	52502-32A	52502-32B	52502-32C
		5MM	45CM	52501-32A	52501-32B	52501-32C
	SCHROEDER TENACULUM GRASPER, SINGLE TOOTH	5MM	33CM	52502-33A	52502-33B	52502-33C
		5MM	45CM	52501-33A	52501-33B	52501-33C



Traditional 5mm Micro-Laparoscopic Instruments



All Stainless Steel Construction w/ Micro Tips & Standard Handle



CURVED MICRO SCISSORS	33 CM	52502-21
	45 CM	52501-21



STRAIGHT MICRO SCISSORS	33 CM	52502-22
	45 CM	52501-22



MICRO GRASPER	33 CM	52502-23
	45 CM	52501-23



DBL-ACTION MICRO GRASPER	33 CM	52502-24
	45 CM	52501-24



MICRO BIOPSY PUNCH	33 CM	52502-25
	45 CM	52501-25

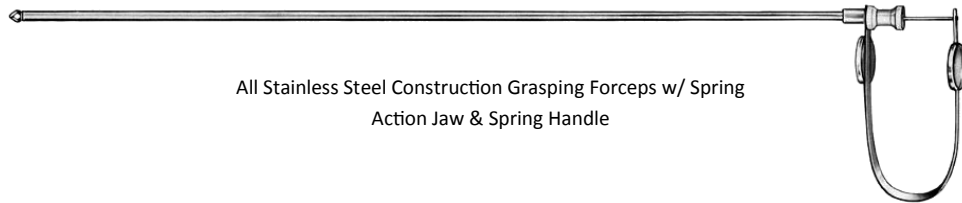

All Stainless Steel Construction Grasping Forceps w/ Spring Action Jaw & Spring Handle



STANDARD GRASPER	33 CM	52502-50
	45 CM	52501-50



ATRAMATIC GRASPER	33 CM	52502-51
	45 CM	52501-51



ATRAMATIC GRASPER W/ STRONG JAW	33 CM	52502-52
	45 CM	52501-52



ROUND BOWEL GRASPER	33 CM	52502-53
	45 CM	52501-53



"T" BOWEL GRASPER	33 CM	52502-54
	45 CM	52501-54

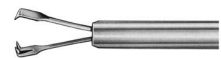

CYST GRASPER	33 CM	52502-55
	45 CM	52501-55















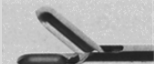

TUBAL GRASPER	33 CM	52502-56
	45 CM	52501-56



FENESTRATED GRASPER	33 CM	52502-57
	45 CM	52501-57











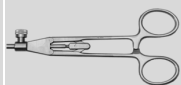
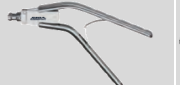

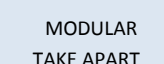

Traditional 10mm Laparoscopic Instruments

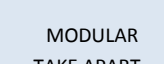
TIP ID.	DESCRIPTION	DIAMETER	LENGTH			
				STANDARD HANDLE	SPRING HANDLE	RATCHET HANDLE
	STRAIGHT SCISSORS	10MM	33CM	52112-01A	52112-01B	52112-01C
		10MM	45CM	52111-01A	52111-01B	52111-01C
	SPOON FORCEPS	10MM	33CM	52112-02A	52112-02B	52112-02C
		10MM	45CM	52111-02A	52111-02B	52111-02C
	CLAW FORCEPS	10MM	33CM	52112-03A	52112-03B	52112-03C
		10MM	45CM	52111-03A	52111-03B	52111-03C
	GRASPING FORCEPS	10MM	33CM	52112-04A	52112-04B	52112-04C
		10MM	45CM	52111-04A	52111-04B	52111-04C
	DEBAKEY STRAIGHT	10MM	33CM	52112-05A	52112-05B	52112-05C
		10MM	45CM	52111-05A	52111-05B	52111-05C
	BABCOCK FORCEPS	10MM	33CM	52112-07A	52112-07B	52112-07C
		10MM	45CM	52111-07A	52111-07B	52111-07C
	ALLIS FORCEPS	10MM	33CM	52112-08A	52112-08B	52112-08C
		10MM	45CM	52111-08A	52111-08B	52111-08C
	MARYLAND FORCEPS	10MM	33CM	52112-09A	52112-09B	52112-09C
		10MM	45CM	52111-09A	52111-09B	52111-09C
	MIXTER FORCEPS 90°	10MM	33CM	52112-10A	52112-10B	52112-10C
		10MM	45CM	52111-10A	52111-10B	52111-10C
	DUVAL FORCEPS	10MM	33CM	52112-11A	52112-11B	52112-11C
		10MM	45CM	52111-11A	52111-11B	52111-11C
	TENACULUM FORCEPS	10MM	33CM	52112-15A	52112-15B	52112-15C
		10MM	45CM	52111-15A	52111-15B	52111-15C
	GLASSMAN FORCEPS	10MM	33CM	52112-16A	52112-16B	52112-16C
		10MM	45CM	52111-16A	52111-16B	52111-16C

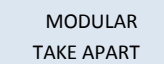

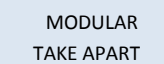
Laparoscopic 5mm Needle Holders

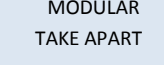
TIP ID.	DIAMETER	LENGTH	INSERT NO.	52555-40-13	52555-40-19	52555-40-20	52555-40-21	52555-40-22
				 STAINLESS STEEL, RING AXIAL HANDLE W/ RATCHET	 LIGHT WEIGHT AXIAL HANDLE, CURVED DOWN W/ RATCHET	 STRAIGHT AXIAL HANDLE SINGLE ACTION W/ RATCHET	 LIGHTWEIGHT STRAIGHT AXIAL HANDLE W/ RATCHET	 STAINLESS STEEL, RING AXIAL HANDLE CURVED DOWN, RATCHET
NON-INSULATED HANDLES								
STRAIGHT 8 MM TC TIP 	5MM	33CM		52505-45	52505-70	52505-85	52505-77	52505-100
	5MM	36CM		52536-45	52536-70	52536-85	52536-77	52536-100
	5MM	45CM		52515-45	52515-70	52515-85	52515-77	52515-100
MODULAR TAKE APART 	5MM	33CM	52505-60I	52505-45C	52505-70C	52505-85C	52505-77C	52505-100C
	5MM	36CM	52536-60I	52536-45C	52536-70C	52536-85C	52536-77C	52536-100C
	5MM	45CM	52515-60I	52515-45C	52515-70C	52515-85C	52515-77C	52515-100C
CURVED LEFT TC TIP 	5MM	33CM		52505-46	52505-71	52505-86	52505-78	52505-101
	5MM	36CM		52536-46	52536-71	52536-86	52536-78	52536-101
	5MM	45CM		52515-46	52515-71	52515-86	52515-78	52515-101
MODULAR TAKE APART 	5MM	33CM	52505-62I	52505-46C	52505-71C	52505-86C	52505-78C	52505-101C
	5MM	36CM	52536-62I	52536-46C	52536-71C	52536-86C	52536-78C	52536-101C
	5MM	45CM	52515-62I	52515-46C	52515-71C	52515-86C	52515-78C	52515-101C
CURVED RIGHT TC TIP 	5MM	33CM		52505-47	52505-72	52505-87	52505-79	52505-102
	5MM	36CM		52536-47	52536-72	52536-87	52536-79	52536-102
	5MM	45CM		52515-47	52515-72	52515-87	52515-79	52515-102
MODULAR TAKE APART 	5MM	33CM	52505-63I	52505-47C	52505-72C	52505-87C	52505-79C	52505-102C
	5MM	36CM	52536-63I	52536-47C	52536-72C	52536-87C	52536-79C	52536-102C
	5MM	45CM	52515-63I	52515-47C	52515-72C	52515-87C	52515-79C	52515-102C
OPEN SELF-RIGHTING NEEDLE TIP 	5MM	33CM		52505-66	52505-73	52505-88	52505-82	52505-103
	5MM	36CM		52536-66	52536-73	52536-88	52536-82	52536-103
	5MM	45CM		52515-66	52515-73	52515-88	52515-82	52515-103
MODULAR TAKE APART 	5MM	33CM	52505-64I	52505-66C	52505-73C	52505-88C	52505-82C	52505-103C
	5MM	36CM	52536-64I	52536-66C	52536-73C	52536-88C	52536-82C	52536-103C
	5MM	45CM	52515-64I	52515-66C	52515-73C	52515-88C	52515-82C	52515-103C
CLOSED SELF-RIGHTING NEEDLE TIP 	5MM	33CM		52505-67	52505-74	52505-89	52505-83	52505-90
	5MM	36CM		52536-67	52536-74	52536-89	52536-83	52536-90
	5MM	45CM		52515-67	52515-74	52515-89	52515-83	52515-90
MODULAR TAKE APART 	5MM	33CM	52505-65I	52505-67C	52505-74C	52505-89C	52505-83C	52505-90C
	5MM	36CM	52536-65I	52536-67C	52536-74C	52536-89C	52536-83C	52536-90C
	5MM	45CM	52515-65I	52515-67C	52515-74C	52515-89C	52515-83C	52515-90C

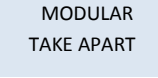

Laparoscopic 5mm Needle Holders

TIP ID.	DIAMETER	LENGTH	INSERT NO.	52555-40-26	52555-40-27	
				 THERMO-PLASTIC AXIAL HANDLE, CURVED DOWN W/ RATCHET	 THERMO-PLASTIC STRAIGHT AXIAL HANDLE SINGLE ACTION W/ RATCHET	 STRAIGHT AXIAL HANDLE, DOUBLE ACTION W/ RATCHET
NON-INSULATED HANDLES						
STRAIGHT 8 MM TC TIP 	5MM	33CM		52505-70P	52505-85P	52505-60
	5MM	36CM		52536-70P	52536-85P	52536-60
	5MM	45CM		52515-70P	52515-85P	52515-60
MODULAR TAKE APART 	5MM	33CM	52505-60I	52505-70CP	52505-85PC	52505-60C
	5MM	36CM	52536-60I	52536-70CP	52536-85PC	52536-60C
	5MM	45CM	52515-60I	52515-70CP	52515-85PC	52515-60C
CURVED LEFT TC TIP 	5MM	33CM		52505-71P	52505-86P	52505-62
	5MM	36CM		52536-71P	52536-86P	52536-62
	5MM	45CM		52515-71P	52515-86P	52515-62
MODULAR TAKE APART 	5MM	33CM	52505-62I	52505-71CP	52505-86PC	52505-62C
	5MM	36CM	52536-62I	52536-71CP	52536-86PC	52536-62C
	5MM	45CM	52515-62I	52515-71CP	52515-86PC	52515-62C
CURVED RIGHT TC TIP 	5MM	33CM		52505-72P	52505-87P	52505-63
	5MM	36CM		52536-72P	52536-87P	52536-63
	5MM	45CM		52515-72P	52515-87P	52515-63
MODULAR TAKE APART 	5MM	33CM	52505-63I	52505-72CP	52505-87PC	52505-63C
	5MM	36CM	52536-63I	52536-72CP	52536-87PC	52536-63C
	5MM	45CM	52515-63I	52515-72CP	52515-87PC	52515-63C
OPEN SELF-RIGHTING NEEDLE TIP 	5MM	33CM		52505-73P	52505-88P	52505-64
	5MM	36CM		52536-73P	52536-88P	52536-64
	5MM	45CM		52515-73P	52515-88P	52515-64
MODULAR TAKE APART 	5MM	33CM	52505-64I	52505-73CP	52505-88PC	52505-64C
	5MM	36CM	52536-64I	52536-73CP	52536-88PC	52536-64C
	5MM	45CM	52515-64I	52515-73CP	52515-88PC	52515-64C
CLOSED SELF-RIGHTING NEEDLE TIP 	5MM	33CM		52505-74P	52505-89P	52505-65
	5MM	36CM		52536-74P	52536-89P	52536-65
	5MM	45CM		52515-74P	52515-89P	52515-65
MODULAR TAKE APART 	5MM	33CM	52505-65I	52505-74CP	52505-89PC	52505-65C
	5MM	36CM	52536-65I	52536-74CP	52536-89PC	52536-65C
	5MM	45CM	52515-65I	52515-74CP	52515-89PC	52515-65C



Knot Pushers

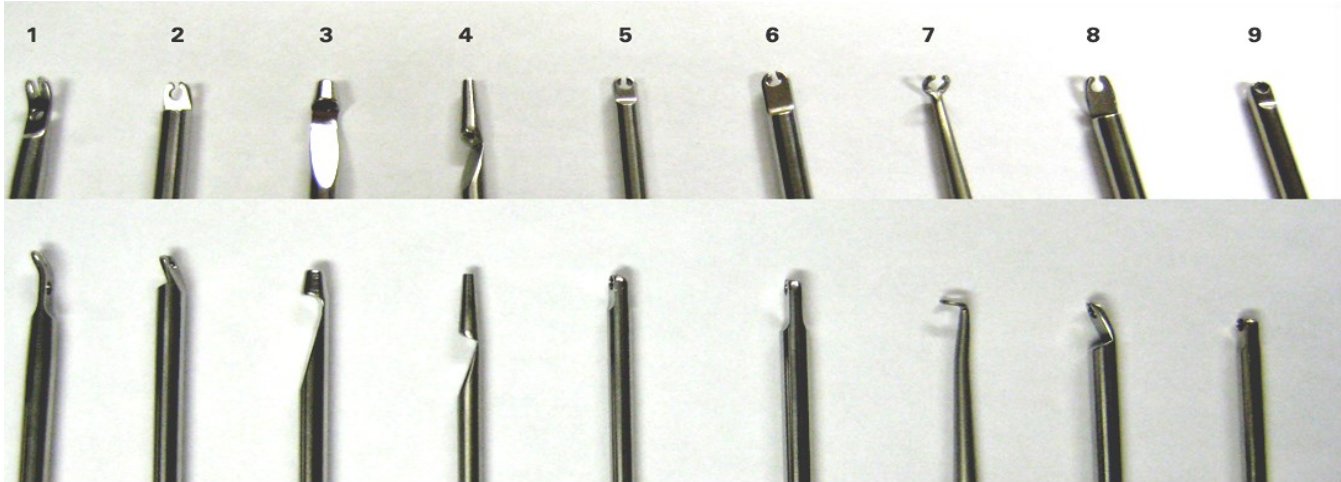

DESCRIPTION	33CM LIST NO.	45CM LIST NO.
KNOT PUSHER, STAINLESS STEEL 5mm DIA., STYLE 1	52205-61-01	52105-61-01
KNOT PUSHER, STAINLESS STEEL 5mm DIA., STYLE 2	52205-61-02	52105-61-02
KNOT PUSHER, STAINLESS STEEL 5mm DIA., STYLE 3	52205-61-03	52105-61-03
KNOT PUSHER, STAINLESS STEEL 5mm DIA., STYLE 4	52205-61-04	52105-61-04
KNOT PUSHER, STAINLESS STEEL 5mm DIA., STYLE 5	52205-61-05	52105-61-05
KNOT PUSHER, STAINLESS STEEL 5mm DIA., STYLE 6	52205-61-06	52105-61-06
KNOT PUSHER, STAINLESS STEEL 5mm DIA., STYLE 7	52205-61-07	52105-61-07
KNOT PUSHER, STAINLESS STEEL 5mm DIA., STYLE 8	52205-61-08	52105-61-08
KNOT PUSHER, STAINLESS STEEL 5mm DIA., STYLE 9	52205-61-09	52105-61-09
KNOT PUSHER, CLOSED, STAINLESS STEEL 5mm DIA., STYLE 1	52205-61-01C	52105-61-01C
KNOT PUSHER, CLOSED, STAINLESS STEEL 5mm DIA., STYLE 2	52205-61-02C	52105-61-02C
KNOT PUSHER, CLOSED, STAINLESS STEEL 5mm DIA., STYLE 5	52205-61-05C	52105-61-05C
KNOT PUSHER, CLOSED, STAINLESS STEEL 5mm DIA., STYLE 6	52205-61-06C	52105-61-06C
KNOT PUSHER, CLOSED, STAINLESS STEEL 5mm DIA., STYLE 7	52205-61-07C	52105-61-07C
KNOT PUSHER, CLOSED, STAINLESS STEEL 5mm DIA., STYLE 8	52205-61-08C	52105-61-08C



Laparoscopic Suture Passer



SPRING HANDLE



SYRINGE STYLE



*PRECISION MICRO-POINTED AND POLISHED
TIP WITH PLATFORM ON ALL OF SUTURE
RETRIEVERS*

LIST NO. 52203-41	LAPAROSCOPIC TROCAR INCISION WOUND CLOSURE & HERNIA SUTURE RETRIEVER- 3.0 MM DIAMETER, 17 CM WORKING LENGTH, SPRING HANDLE, CLEANING FLUSH PORT
LIST NO. 52203-41C	LAPAROSCOPIC TROCAR INCISION WOUND CLOSURE & HERNIA SUTURE RETRIEVER- 3.0 MM DIAMETER, 17 CM WORKING LENGTH, SPRING HANDLE, CLEANING FLUSH PORT (2-PIECE TAKE APART)
LIST NO. 52213-41	BARIATRIC LAPAROSCOPIC TROCAR INCISION WOUND CLOSURE & HERNIA SUTURE RETRIEVER- 3.0 MM DIAMETER, 20 CM WORKING LENGTH, SPRING HANDLE, CLEANING FLUSH PORT
LIST NO. 52213-41C	BARIATRIC LAPAROSCOPIC TROCAR INCISION WOUND CLOSURE & HERNIA SUTURE RETRIEVER- 3.0 MM DIAMETER, 20 CM WORKING LENGTH, SPRING HANDLE, CLEANING FLUSH PORT (2-PIECE TAKE APART)
LIST NO. 52203-00	LAPAROSCOPIC TROCAR INCISION WOUND CLOSURE & HERNIA SUTURE RETRIEVER- 3.0 MM DIAMETER, 17 CM WORKING LENGTH, SY-RINGE HANDLE, CLEANING FLUSH PORT,
LIST NO. 52213-00	LAPAROSCOPIC TROCAR INCISION WOUND CLOSURE & HERNIA SUTURE RETRIEVER- 3.0 MM DIAMETER, 20 CM WORKING LENGTH, SY-RINGE HANDLE, CLEANING FLUSH PORT,

Stainless Steel Trocar Guide Cones

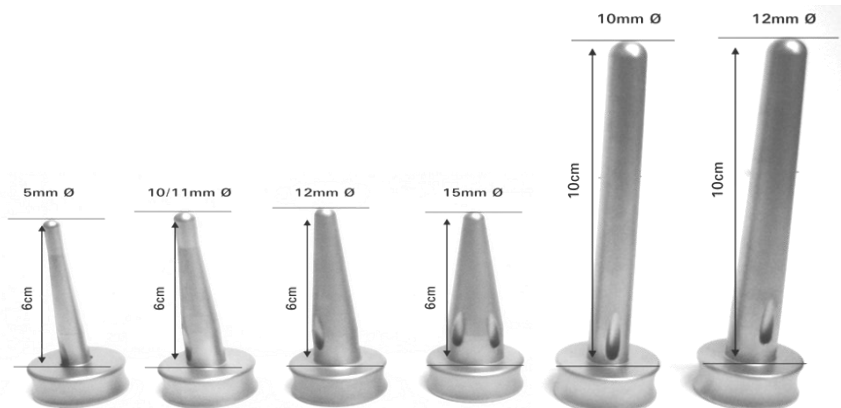

6CM LENGTH		10CM LENGTH	
LIST NO. 52203-05	5MM DIAMETER	LIST NO. 52204-05	5MM DIAMETER
LIST NO. 52203-10/11	10/11MM DIAMETER	LIST NO. 52204-10/11	10/11MM DIAMETER
LIST NO. 52203-12	12MM DIAMETER	LIST NO. 52204-12	12MM DIAMETER
LIST NO. 52203-15	15MM DIAMETER	LIST NO. 52204-15	15MM DIAMETER

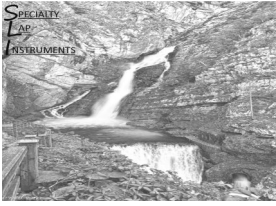

Hasson 3-Prong Grasper

The Ultimate Laparoscopic Instrument for Retraction of Myomas, Fibroids, Ovaries & Other Organs



LIST NO. 52505-52	5MM, 32CM, 3-PRONG BULLDOG HASSON GRASPER AGGRESSIVE JAWS
LIST NO. 52515-52	5MM, 45CM, 3-PRONG BULLDOG HASSON GRASPER AGGRESSIVE JAWS

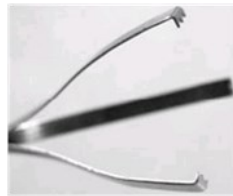

LIST NO. 52505-53	5MM, 32CM, 3-PRONG HASSON GRASPER, CURVED ALLIS TEETH
LIST NO. 52515-53	5MM, 45CM, 3-PRONG HASSON GRASPER, CURVED ALLIS TEETH

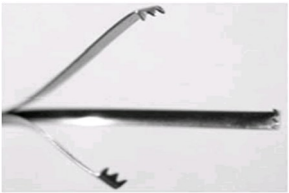

LIST NO. 52505-54	5MM, 32CM, 3-PRONG HASSON GRASPER, STRAIGHT ALLIS TEETH
LIST NO. 52515-54	5MM, 45CM, 3-PRONG HASSON GRASPER, STRAIGHT ALLIS TEETH

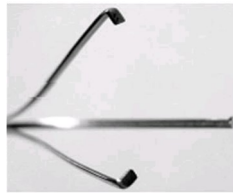

LIST NO. 52505-55	5MM, 32CM, 3-PRONG HASSON GRASPER, BLUNT EDGED JAWS
LIST NO. 52515-55	5MM, 45CM, 3-PRONG HASSON GRASPER, BLUNT EDGED JAWS

Myoma Screw



Precision Machined Tip

Solid stainless steel construction with precision machined tip for precise manipulation and securing of thick walled myomas.
Completely reusable, helping reduce your spiraling surgical procedure costs.

LIST NO. 52505-98	5MM Ø, 33CM WORKING LENGTH MYOMA SCREW
LIST NO. 52515-98	5MM Ø, 45CM WORKING LENGTH MYOMA SCREW

LIST NO. 52505-99	10MM Ø, 33CM WORKING LENGTH MYOMA SCREW
LIST NO. 52515-99	10MM Ø, 45CM WORKING LENGTH MYOMA SCREW

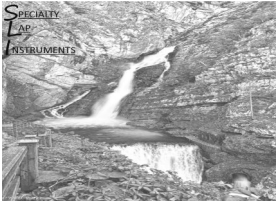

Cholangiogram Clamp

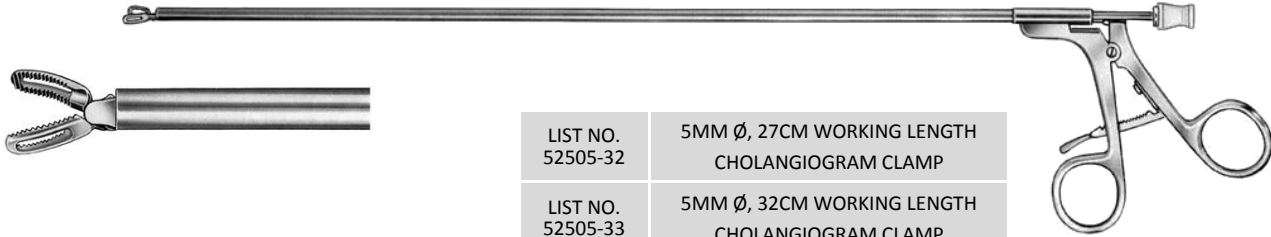

LIST NO. 52505-32	5MM Ø, 27CM WORKING LENGTH CHOLANGIOGRAM CLAMP
LIST NO. 52505-33	5MM Ø, 32CM WORKING LENGTH CHOLANGIOGRAM CLAMP
LIST NO. 52505-34	5MM Ø, 36CM WORKING LENGTH CHOLANGIOGRAM CLAMP
LIST NO. 52505-35	5MM Ø, 45CM WORKING LENGTH CHOLANGIOGRAM CLAMP

*All 5mm Diameter,
4 Different Working Lengths*

Endoscopic Magnetic Rod

Stainless Steel Construction With Serrated Handle for Precise
Important: Instrument to be used ONLY under direct vision



LIST NO. 52805-01	5MM Ø, 33CM LAPAROSCOPIC MAGNETIC ROD	LIST NO. 52810-01	10MM Ø, 33CM LAPAROSCOPIC MAG- NETIC ROD
LIST NO. 52805-02	5MM Ø, 45CM LAPAROSCOPIC MAGNETIC ROD	LIST NO. 52810-02	10MM Ø, 45CM LAPAROSCOPIC MAGNETIC ROD
LIST NO. 52803-01	3MM Ø, 33CM LAPAROSCOPIC MAGNETIC ROD		
LIST NO. 52803-02	3MM Ø, 45CM LAPAROSCOPIC MAGNETIC ROD		

Retractable Endoscopic Knife

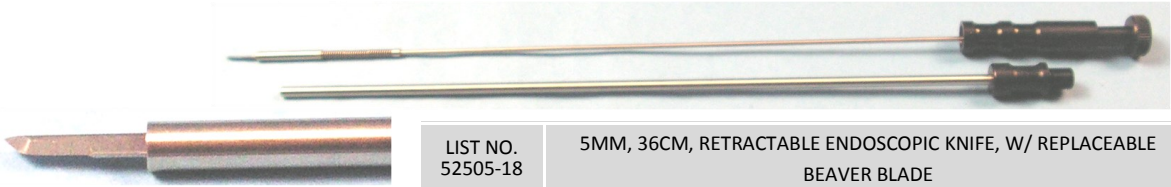

LIST NO. 52505-18	5MM, 36CM, RETRACTABLE ENDOSCOPIC KNIFE, W/ BEAVER BLADE
----------------------	---

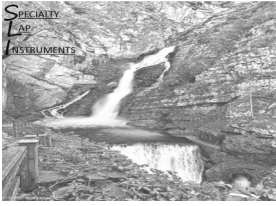

Silastic Ring Applicator for Tubular Sterilization

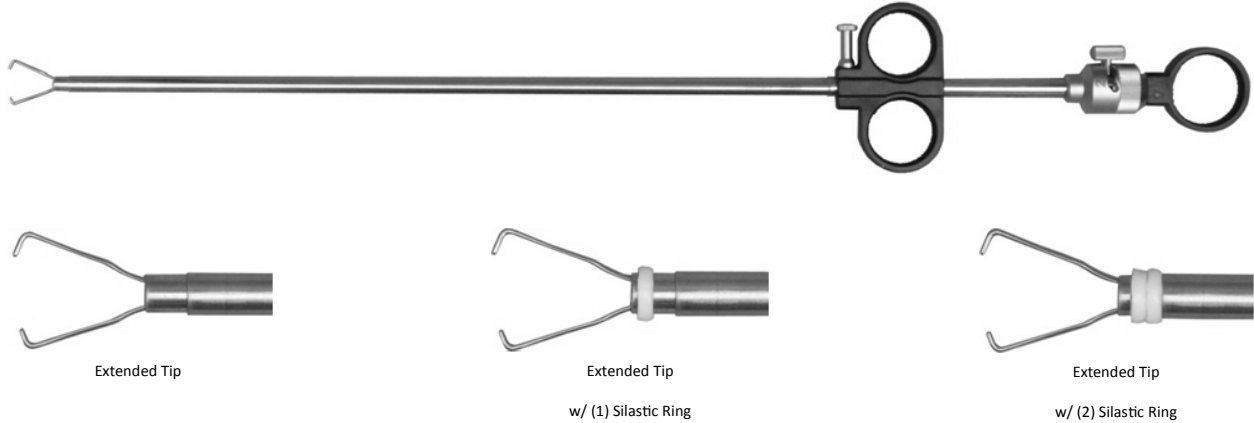

LIST NO. 52105-500	6MM Ø, 40CM SILASTIC RING APPLICATOR- FOR SINGLE AND DUAL RING APPLICATION; USE WITH OPERATING LAPAROSCOPE WITH 6MM Ø INSTRUMENT CHANNEL (SUGGEST LIST NO. 52110-06).
LIST NO. 52205-501	6 MM Ø, 33 CM SILASTIC RING APPLICATOR FOR SINGLE AND DUAL RING APPLICATION; USE WITH LAPAROSCOPE AND 6MM Ø TROCAR SLEEVE (SEE DATA SHEET FOR APPROPRIATE SLEEVE).
LIST NO. 52208-501	8 MM Ø, 27 CM SILASTIC RING APPLICATOR- FOR SINGLE AND DUAL RING APPLICATION; USE WITH LAPAROSCOPE AND 8MM Ø TROCAR SLEEVE (SEE DATA SHEET FOR APPROPRIATE SLEEVE). SAME DIAMETER AS ACMI
LIST NO. 52208-501	8 MM Ø, 33 CM SILASTIC RING APPLICATOR- FOR SINGLE AND DUAL RING APPLICATION; USE WITH LAPAROSCOPE AND 8MM Ø TROCAR SLEEVE (SEE DATA SHEET FOR APPROPRIATE SLEEVE). SAME DIAMETER AS ACMI
LIST NO. 52005-500	SILASTIC RING (PACKAGE OF 10) FOR TUBAL LIGATION NON-STERILE, AUTOCLAVABLE
LIST NO. 52005-501	SILASTIC RING APPLIER AND GUIDE CONE SET (NOTE: (1) SET COMES WITH NEW INSTRUMENT)

Cohen Cannula



LIST NO. 52001-13	COHEN CANNULA 2/ LARGE/SMALL REPLACEABLE TIPS
LIST NO. 52001-19L	REPLACEMENT ACORN, LARGE, FOR 52001-13
LIST NO. 52001-19S	REPLACEMENT ACORN, SMALL, FOR 52001-13
LIST NO. 52001-13W	COHEN CANNULA WITH LARGE/SMALL REPLACABLE TIPS- SLOTTED HANDLE-WOLF STYLE
LIST NO. 52001-29	3MM CLEANING BRUSH FOR FRONT TUBE OF COHEN CANNULA (QTY 12/PACK)
LIST NO. 52001-31	5MM CLEANING BRUSH FOR REAR TUBE OF COHEN CANNULA (QTY 12/PACK)

LIST NO. 52001-12S	COHEN CANNULA WITH FIXED SMALL STAINLESS STEEL ACORN
LIST NO. 52001-12L	COHEN CANNULA WITH FIXED LARGE STAINLESS STEEL ACORN
LIST NO. 52001-29	3MM CLEANING BRUSH FOR FRONT TUBE OF COHEN CANNULA (QTY 12/PACK)
LIST NO. 52001-31	5MM CLEANING BRUSH FOR REAR TUBE OF COHEN CANNULA (QTY 12/PACK)

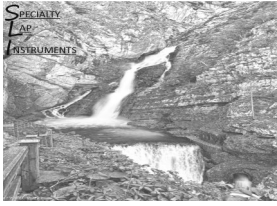

Uterine Manipulator

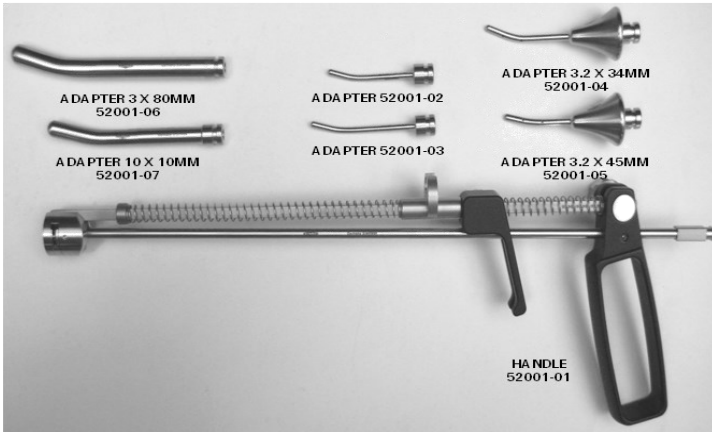
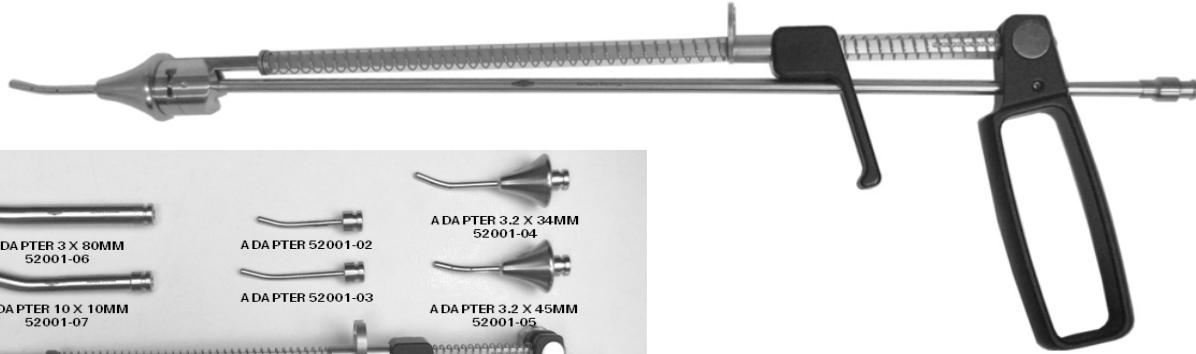

LIST NO. 52001-00

V/T (VALTEHER/PELOSI) UTERINE MANIPULATOR: COMPLETE W/ SET OF (6) INTERCHANGEABLE OBTURATORS & CANNULA

Uterine Tenacula

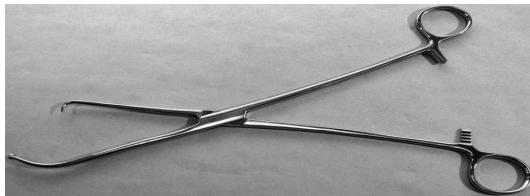

LIST NO. 52001-09

HULKA UTERINE MANIPULATOR TENACULUM

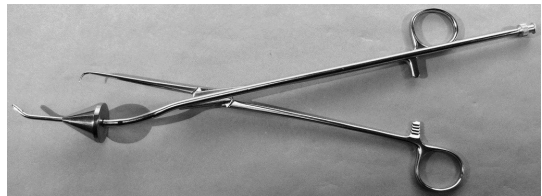

LIST NO. 52001-16

BEHRMAN UTERINE MANIPULATOR TENACULUM

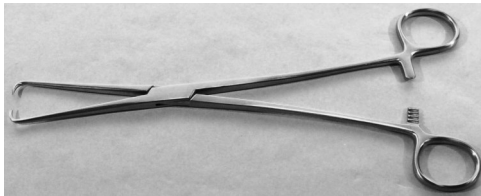

LIST NO. 52001-14

SCHROEDER TENACULUM SINGLE TOOTH (9 1/2")

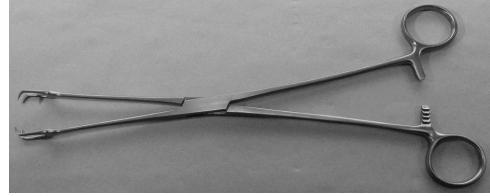

LIST NO. 52001-08

SCHROEDER VULSELLUM DOUBLE TOOTH (9 1/2")

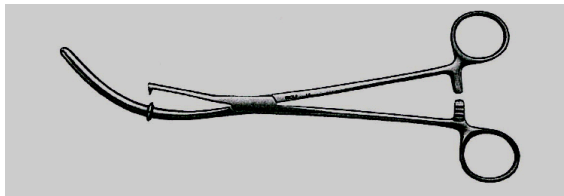

LIST NO. 52001-18

SARGIS UTERINE GRASPING FORCEPS (9 1/2")

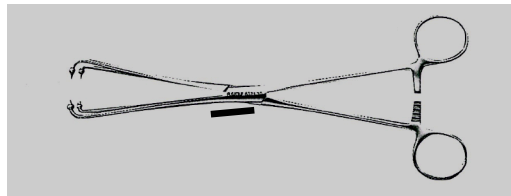

LIST NO. 52001-17

GIMPELSON CERVICAL SEALING TENACULUM (9 1/2")

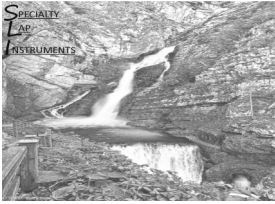

Aspiration Needles

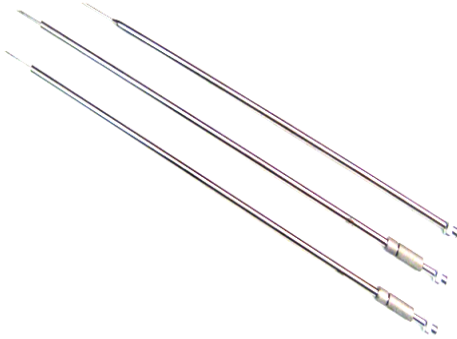

LIST NO. 52103-19	3MM, 45CM INJECTION, ASPIRATION, & BIOPSY NEEDLE
LIST NO. 52803-02	5MM, 45CM ASPIRATION NEEDLE, 15 GA. NEEDLE SIZE- STANDARD (18 GA TO 25 GA AVAILABLE-PLEASE SPECIFY)
LIST NO. 52105-27R	5MM, 45CM RETRACTABLE ASPIRATION NEEDLE, 15 GA. NEEDLE SIZE-STANDARD (18 GA. TO 25 GA. AVAILABLE - PLEASE SPECIFY)
LIST NO. 52105-27W	5MM DIA., 45CM ASPIRATION NEEDLE, WITH ANGLED 45 DEGREE TUBE, 15 GA. NEEDLE SIZE - STANDARD (18 GA. TO 25 GA. AVAILABLE - PLEASE SPECIFY)
LIST NO. 52203-22	3MM DIA., 33CM INJECTION, ASPIRATION AND BIOPSY NEEDLE
LIST NO. 52205-31	5MM DIA., 33CM ASPIRATION NEEDLE 15 GA. NEEDLE SIZE - STANDARD (18 GA. TO 25 GA. AVAILABLE - PLEASE SPECIFY)
LIST NO. 52205-31R	5MM DIA., 33CM RETRACTABLE ASPIRATION NEEDLE 15 GA. NEEDLE SIZE - (STANDARD 18 GA. TO 25 GA. AVAILABLE - PLEASE SPECIFY)

Verres Needles



LIST NO. 52003-07	2 MM DIA., 260 MM (10") VERESS INSUFLATION NEEDLE	LIST NO. 52003-10	2 MM DIA., 100 MM (4") VERESS INSUFLATION NEEDLE
LIST NO. 52003-08	2 MM DIA., 180 MM (7") VERESS INSUFLATION NEEDLE	LIST NO. 52003-11	2 MM DIA., 120 MM (5") VERESS INSUFLATION NEEDLE
LIST NO. 52003-09	2 MM DIA., 55 MM (2") VERESS INSUFLATION NEEDLE	LIST NO. 52003-12	2 MM DIA., 150 MM (6") VERESS INSUFLATION NEEDLE

Palpation Tactile Probes W/ CM Markings



LIST NO. 52205-29	5MM, 33CM, PALPATION TACTILE PROBE W/ CM MARKINGS
LIST NO. 52105-25	5MM, 45CM, PALPATION TACTILE PROBE W/ CM MARKINGS
LIST NO. 52133-25	10MM, 33CM, PALPATION TACTILE PROBE W/ CM MARKINGS
LIST NO. 52145-25	10MM, 45CM, PALPATION TACTILE PROBE W/ CM MARKINGS



Retract Robot in Laparoscopic Surgery

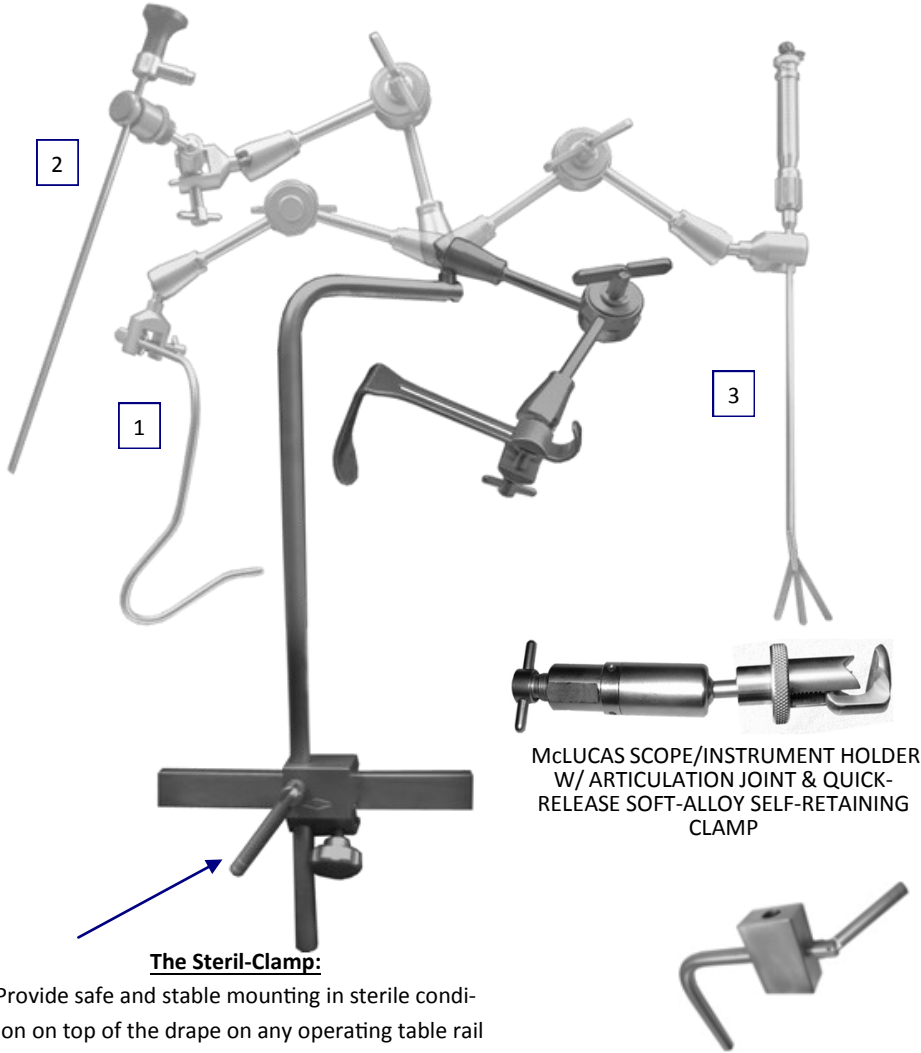

The Steril-Clamp:

Provide safe and stable mounting in sterile condition on top of the drape on any operating table rail

VARIOUS INSTRUMENTS SHOWN WITH THE SINGLE-ARM RETRACT-ROBOT:

- 1) With the Nathanson Liver Retractor
- 2) With the articulating scope holder: quick, stable & precise adjustment can be made with the turn of a knob.
- 3) With the Fan Retractor; any type of retractor can be held in a stable, fully adjustable position at maximum retraction, e.g. flat, round, etc.

EXTENSION CLAMP FOR BARIATRIC SURGERY (FITS INTO STERIL-CLAMP)

LIST NO	DESCRIPTION
15088-00	IRETRACT-ROBOT SINGLE ARM INSTRUMENT
15088-01	RETRACT-ROBOT SINGLE ARM INSTRUMENT W/ EXTRA-LONG MOUNTING ROD (26") (BARIATRIC)
15090-53	STERIL-CLAMP HEAVY DUTY, 5/8" ROUND HOLE OR 1/2" X 1" SLOT (FOR EXTRA LONG ROBOT ARM)
15090-56	STERIL-CLAMP STANDARD, AUTOCLAVABLE W/ ROUND 5/8" ACCESSORY OPENING
15090-57	EXTENSION CLAMP FOR BARIATRIC SURGERY: AUTOCLAVABLE, 5/8" ACCESSORY OPENING
52410-01	ISCOPE/INSTRUMENT HOLDER W/ ARTICULATION JOINT SELF-RETAINING CLAMP (SLEEVE STYLE)
52400-00	ENODOSCOPIC FIXATION DEVICE CONSISTING OF:LIST NO.'S: 15088-00, 15090-56, & 52410-01
52400-01	BARIATRIC ENODOSCOPIC FIXATION DEVICE CONSISTING OF LIST NO.'S: 15088-01, 15090-53, & 52410-01

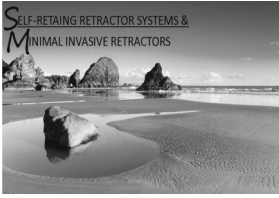

Goose Neck Retractor in Laparoscopic Surgery

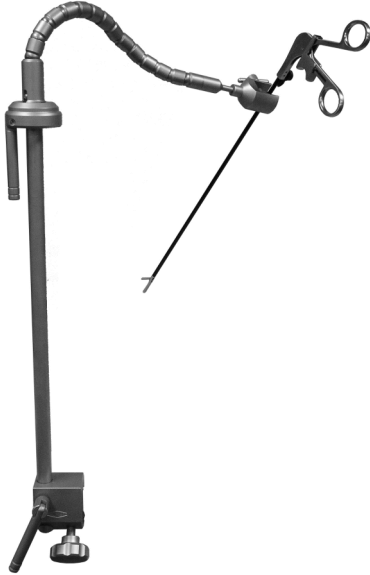

Features of the Goose-Neck System:

- All components are made of a high grade stainless steel.
- The complete system, including the Steril-Clamp™, may be flash auto-claved
- The self-retaining joints rotate & twist in every desirable position
- The instrument shaft fits into table accessory clamps such as those used for stirrups & leg holders, as well as all of the other over-the-drape clamps with an opening of 5/8"
- The vertical shaft (5/8") may be lowered or heightened within the clamp for flexible adjustment
- Two different models with different instrument holders available

LIST NO. 15090-60	GOOSE-NECK RETRACTOR SYSTEM WITH SELF-RETAINING SLEEVE CLAMP WITH ARTICULATING JOINT FOR HOLDING TELESCOPES INCLUDES 15090-56: STERIL-CLAMP™ FOR ATTACHING TO TABLE
LIST NO. 15090-61	GOOSE-NECK RETRACTOR SYSTEM WITH UNIVERSAL MOUNTING CLAMP FOR HOLDING ALL TYPES OF INSTRUMENTS INCLUDES 15090-56: STERIL-CLAMP™ FOR ATTACHING TO TABLE

Retract Robot & Goose Neck Retractor Sterilization Containers

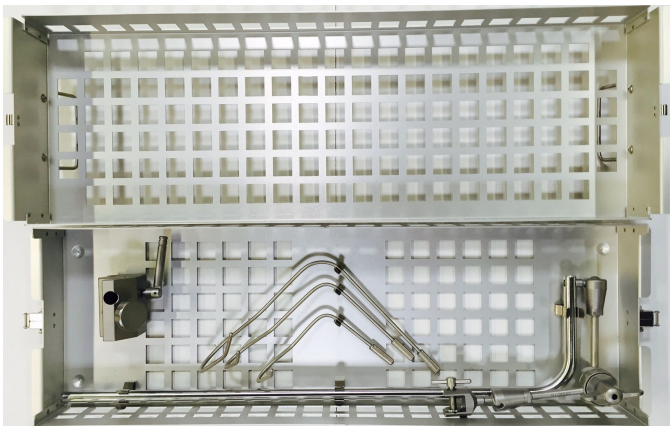

LIST NO. 55040-03	ALUMINUM STORAGE/STERILIZATION CONTAINER w/ PERFO-RATED LID & BOTTOM, w/ BRACKETS FOR MOUNTING RETRACT-ROBOT #15088-00 & #15090-53 or 15090-56. FOR WRAPPING.) DIMENSIONS: 26"L x 10"W x 7"H (63.5CM x 25CM x 13CM).
LIST NO. 55040-02	ALUMINUM STORAGE/STERILIZATION CONTAINER w/ PERFORATED LID & BOTTOM, w/ BRACKETS FOR MOUNTING RETRACT-ROBOT #15088-01 or 15088-03 & STERIL CLAMP #15090-53 or 15090-56. (FOR WRAPPING.) DIMENSIONS: 30"L x 10"W x 6"H (76CM x 25CM x 15CM).



Nathanson Liver Retractors

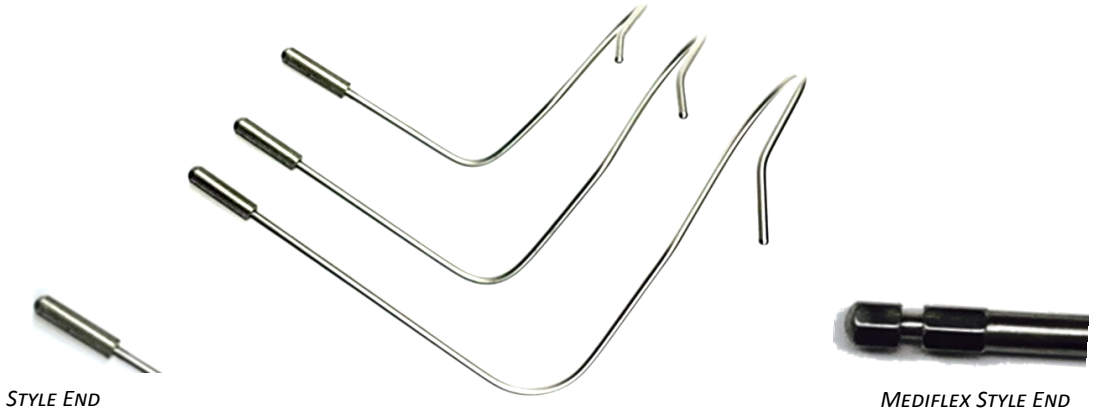

52420-00	NATHANSON STYLE LIVER RETRACTORS 6.5MM DIA. SET OF THREE - SIZES: SMALL, MEDIUM, LARGE
52420-01	NATHANSON STYLE LIVER RETRACTORS, 6.5MM DIA. - SIZE: SMALL
52420-02	NATHANSON STYLE LIVER RETRACTORS, 6.5MM DIA. - SIZE: MEDIUM
52420-03	NATHANSON STYLE LIVER RETRACTORS, 6.5MM DIA. - SIZE: LARGE

52440-00	NATHANSON STYLE LIVER RETRACTORS, 6.5MM DIA. - SET OF THREE - SIZES: SMALL, MEDIUM, LARGE
52440-01	NATHANSON STYLE LIVER RETRACTORS, 6.5MM DIA. SIZE: SMALL
52440-02	NATHANSON STYLE LIVER RETRACTORS, 6.5MM DIA. SIZE: MEDIUM
52440-03	NATHANSON STYLE LIVER RETRACTORS, 6.5MM DIA. SIZE: LARGE

52430-00	NATHANSON STYLE LIVER RETRACTORS, 5MM DIA. - SET OF THREE - SIZES: SMALL, MEDIUM, LARGE
52430-01	NATHANSON STYLE LIVER RETRACTORS, 5MM DIA. SIZE: SMALL
52430-02	NATHANSON STYLE LIVER RETRACTORS, 5MM DIA. SIZE: MEDIUM
52430-03	NATHANSON STYLE LIVER RETRACTORS, 5MM DIA. SIZE: LARGE
52430-04	NATHANSON STYLE LIVER RETRACTORS, 5MM DIA. SIZE: EXTRA SMALLL

52450-00	NATHANSON STYLE LIVER RETRACTORS, 5MM DIA. - SET OF THREE - SIZES: SMALL, MEDIUM, LARGE
52450-01	NATHANSON STYLE LIVER RETRACTORS, 5MM DIA. SIZE: SMALL
52450-02	NATHANSON STYLE LIVER RETRACTORS, 5MM DIA. SIZE: MEDIUM
52450-03	NATHANSON STYLE LIVER RETRACTORS, 5MM DIA. SIZE: LARGE
52450-04	NATHANSON STYLE LIVER RETRACTORS, 5MM DIA. SIZE: EXTRA SMALLL

52460-00	NATHANSON STYLE LIVER RETRACTORS, 3.2MM DIA. - SET OF THREE - SIZES: SMALL, MEDIUM, LARGE
52460-03	NATHANSON STYLE LIVER RETRACTORS, 3.2MM DIA. SIZE: SMALL
52460-04	NATHANSON STYLE LIVER RETRACTORS, 3.2MM DIA. SIZE: MEDIUM
52460-05	NATHANSON STYLE LIVER RETRACTORS, 3.2MM DIA. SIZE: LARGE
52460-06	NATHANSON STYLE LIVER RETRACTORS, 3.2MM DIA. SIZE: EXTRA SMALLL

52460-00	NATHANSON STYLE LIVER RETRACTORS, 3.2MM DIA. - SET OF THREE - SIZES: SMALL, MEDIUM, LARGE
52460-01	NATHANSON STYLE LIVER RETRACTORS, 3.2MM DIA. SIZE: SMALL
52460-02	NATHANSON STYLE LIVER RETRACTORS, 3.2MM DIA. SIZE: MEDIUM
52460-03	NATHANSON STYLE LIVER RETRACTORS, 3.2MM DIA. SIZE: LARGE
52460-04	NATHANSON STYLE LIVER RETRACTORS, 3.2MM DIA. SIZE: EXTRA SMALLL



90° Articulating Flat Blade Retractors

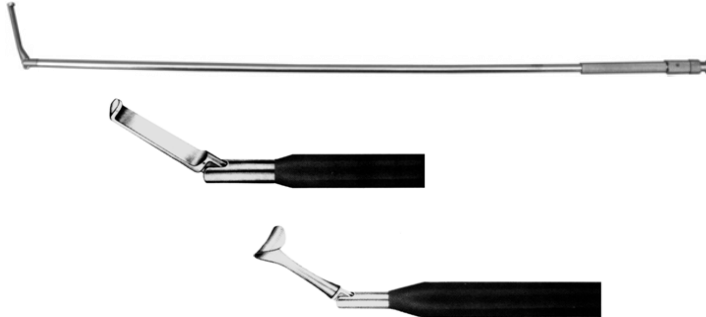

LIST NO. 52505-48	5 MM Ø, 33 CM RETRACTOR; 90 DEGREE ARTICULATING FLAT BLADE, WITH FLUSH PORT
LIST NO. 52515-48	5 MM Ø, 45 CM RETRACTOR; 90 DEGREE ARTICULATING FLAT BLADE, WITH FLUSH PORT
LIST NO. 52510-87	10 MM Ø, 33 CM RETRACTOR; 90 DEGREE ARTICULATING FLAT BLADE, WITH FLUSH PORT
LIST NO. 52511-87	10 MM Ø, 45 CM RETRACTOR; 90 DEGREE ARTICULATING FLAT BLADE, WITH FLUSH PORT
LIST NO. 52510-86	10 MM Ø, 33 CM RETRACTOR; 90 DEGREE ARTICULATING "CUSHING"-TYPE BLADE, WITH FLUSH PORT
LIST NO. 52511-86	10 MM Ø, 45 CM RETRACTOR; 90 DEGREE ARTICULATING "CUSHING"-TYPE BLADE, WITH FLUSH PORT

Lap Banding Retractors



LIST NO. 52525-21	5 MM DIA., 36 CM, ESOPHAGEAL RETRACTOR FOR APPLICATION GASTRIC BANDING 90 DEGREE ARTICULATING
LIST NO. 52515-21	10 MM DIA., 36 CM, ESOPHAGEAL RETRACTOR FOR APPLICATION GASTRIC BANDING 90 DEGREE ARTICULATING DISTAL TIP, FLUSH PORT
LIST NO. 52525-30	5MM DIA., 41CM, ESOPHAGEAL RETRACTOR FOR APPLICATION GASTRIC BANDING 90 DEGREE ARTICULATING
LIST NO. 52515-30	10MM DIA., 41CM, ESOPHAGEAL RETRACTOR WITH ARTICULATING CONTROL KNOB ON HANDLE, WITH FLUSHPORT

Lap Banding Retractors W/ Ratchet Handle



LIST NO. 52525-21B4	5MM DIA., 34CM ARTICULATING RETRACTOR FOR LAP BANDING HANDLE W/ RATCHET, ROTATING-ONE PIECE W/FLUSH PORT
LIST NO. 52515-21B4	10 MM DIA., 34 CM ARTICULATING RETRACTOR FOR LAP BANDING HANDLE W/ RATCHET, ROTATING-ONE PIECE W/FLUSH PORT
LIST NO. 52525-30B4	5MM DIA., 41CM, ESOPHAGEAL RETRACTOR-GASTRIC BAND MANIPULATOR 90 DEG. ANGULATION WITH RING RATCHET HANDLE RIGID - ONE PIECE WITH FLUSH PORT
LIST NO. 52515-30B4	10MM DIA., 41CM, ESOPHAGEAL RETRACTOR-GASTRIC BAND MANIPULATOR, 90 DEG., ANGULATION, WITH RING RATCHET HANDLE, ROTATABLE- ONE PIECE W/FLUSH PORT

Snake Retractors

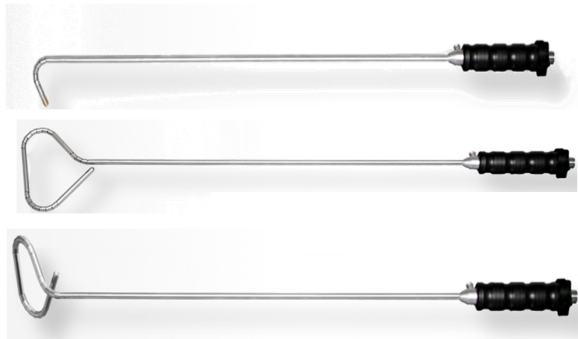

LIST NO. 52550-07	5MM, 40CM LAPAROSCOPIC RETRACTOR W/ FLEXIBLE, RIGHT ANGLED, FORMABLE TIP
LIST NO. 52550-05	5 MM DIA., 40 CM, LAPAROSCOPIC RETRACTOR W/ FLEXIBLE TRIANGULAR FORMABLE TIP
LIST NO. 52550-06	5MM, 40CM LAPAROSCOPIC RETRACTOR W/ FLEXIBLE TRIANGULAR, RIGHT ANGLED FORMABLE TIP



Fan Retractors

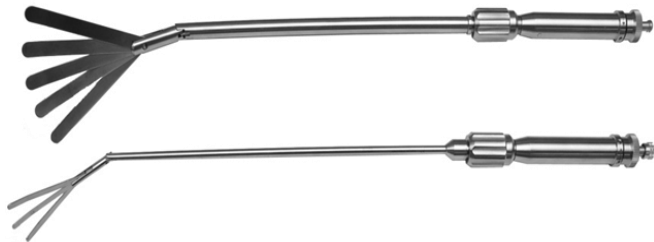

LIST NO. 52505-15	5 MM Ø, 34 CM ARTICULATING FAN RETRACTOR RETRACTOR / ELEVATOR WITH 3 FLAT, 60 DEGREE ARTICULATING AND FOLDING BLADES, (60 MM MAX WIDTH), ADJUSTABLE HANDLE WITH FLUSHPORT, STAINLESS STEEL
LIST NO. 52510-15	10 MM Ø, 34 CM ARTICULATING FAN RETRACTOR RETRACTOR / ELEVATOR WITH 5 FLAT, 60 DEGREE ARTICULATING AND FOLDING BLADES, (90 MM MAX WIDTH), ADJUSTABLE HANDLE WITH FLUSHPORT, STAINLESS STEEL
LIST NO. 52525-15	5 MM Ø, 45 CM ARTICULATING FAN RETRACTOR RETRACTOR / ELEVATOR WITH 3 FLAT, 60 DEGREE ARTICULATING AND FOLDING BLADES, (60 MM MAX WIDTH), ADJUSTABLE HANDLE WITH FLUSHPORT, STAINLESS STEEL
LIST NO. 52515-15	10 MM Ø, 45 CM ARTICULATING FAN RETRACTOR RETRACTOR / ELEVATOR WITH 5 FLAT, 60 DEGREE ARTICULATING AND FOLDING BLADES, (90 MM MAX WIDTH), ADJUSTABLE HANDLE WITH FLUSHPORT, STAINLESS STEEL

Kite Retractors

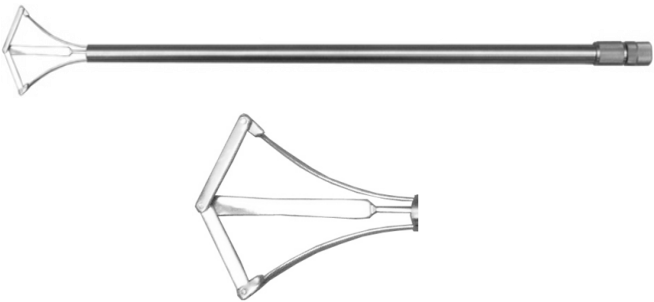

LIST NO. 52505-50	5 MM Ø, 33 CM RETRACTOR/ELEVATOR CURVED, ROTATABLE, TRIANGULAR KITE-SHAPED BLADE, LOCKING HANDLE
LIST NO. 52515-50	5 MM Ø, 45 CM RETRACTOR/ELEVATOR CURVED, ROTATABLE, TRIANGULAR KITE-SHAPED BLADE, LOCKING HANDLE
LIST NO. 52505-51	5 MM Ø, 33 CM RETRACTOR/ELEVATOR STRAIGHT, ROTATABLE, TRIANGULAR KITE-SHAPED BLADE, LOCKING HANDLE
LIST NO. 52515-51	5 MM Ø, 45 CM RETRACTOR/ELEVATOR STRAIGHT, ROTATABLE, TRIANGULAR KITE-SHAPED BLADE, LOCKING HANDLE
LIST NO. 52510-50	5 MM Ø, 45 CM RETRACTOR/ELEVATOR CURVED, ROTATABLE, TRIANGULAR KITE-SHAPED BLADE, LOCKING HANDLE
LIST NO. 52511-50	10 MM Ø, 45 CM RETRACTOR/ELEVATOR STRAIGHT, ROTATABLE, TRIANGULAR KITE-SHAPED BLADE, LOCKING HANDLE

Minimally Invasive Retractors/Elevators



LIST NO. 52505-40	5 MM Ø, 33 CM RETRACTOR/ELEVATOR 90 DEGREE ARTICULATING TEFLON TIP, ACCORDING TO DR. VALLE, WITH FLUSH
LIST NO. 52505-51	5 MM Ø, 33 CM ELEVATOR/PROBE STRAIGHT, TEFLON TIP, ACCORDING TO DR. VALLE
LIST NO. 52505-39	5 MM Ø, 33 CM LEVER/ELEVATOR RETRACTABLE, STRAIGHT, 4-FINGER BLADES, ROTATABLE INSERT
LIST NO. 52515-39	5 MM Ø, 45 CM LEVER/ELEVATOR RETRACTABLE, STRAIGHT, 4-FINGER BLADES, ROTATABLE INSERT



The Original Kleppinger Bipolar Laparoscopic Forceps



SYRINGE-TYPE KLEPPINGER BIPOLAR FORCEPS

5MM DIAMETER, 32CM LENGTH		5MM DIAMETER, 45CM LENGTH	
LIST NO.	DESCRIPTION	LIST NO.	DESCRIPTION
52205-100	FLAT TIP	52105-100	FLAT TIP
52205-100S	STANDARD TIP	52105-100S	STANDARD TIP
52205-100T	FENESTRATED TIP	52105-100T	FENESTRATED TIP
52205-100M	MICRO TIP	52105-100M	MICRO TIP

Bipolar Cables For Kleppinger Forceps



WOLF KLEPPINGER PLUG & DUAL-BANANA GENERATOR PLUG

LIST NO. 52005-24

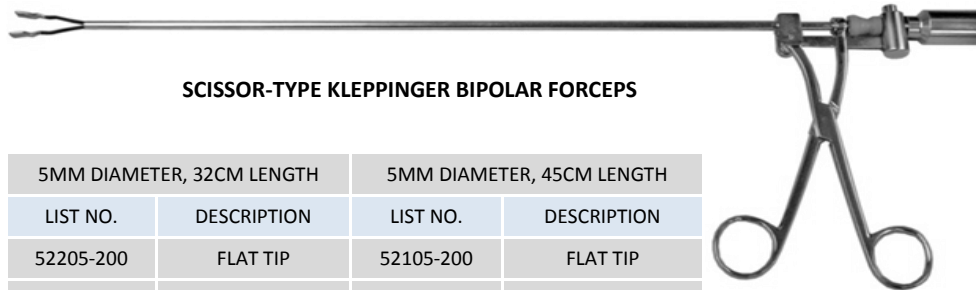

SCISSOR-TYPE KLEPPINGER BIPOLAR FORCEPS

5MM DIAMETER, 32CM LENGTH		5MM DIAMETER, 45CM LENGTH	
LIST NO.	DESCRIPTION	LIST NO.	DESCRIPTION
52205-200	FLAT TIP	52105-200	FLAT TIP
52205-200S	STANDARD TIP	52105-200S	STANDARD TIP
52205-200T	FENESTRATED TIP	52105-200T	FENESTRATED TIP
52205-200M	MICRO TIP	52105-200M	MICRO TIP

OR



WOLF KLEPPINGER PLUG & WOLF GENERATOR PLUG

LIST NO. 52005-23

Reusable Replacement Tongs For Kleppinger Type Forceps

All of our inner tongs are interchangeable with the original Wolf style

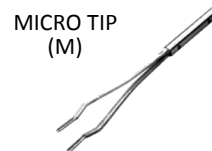
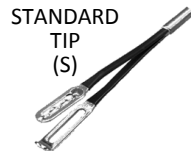
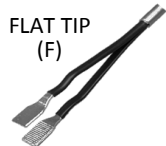

LIST NO.	DESCRIPTION
52205-101	32 CM - FLAT TIP (ORIGINAL KLEPPINGER) INNER TONG - F
52105-101	45 CM - FLAT TIP (ORIGINAL KLEPPINGER) INNER TONG - F
52205-102	32 CM - STANDARD TIP (FENESTRATED WITH WIRE) - INNER TONG - S
52105-102	45 CM - STANDARD TIP (FENESTRATED WITH WIRE) - INNER TONG - S
52205-103	32 CM - MICRO TIP (NARROW SHORT TIP) - INNER TONG - M
52105-103	45 CM - MICRO TIP (NARROW SHORT TIP) - INNER TONG - M
52205-104	32 CM - FENESTRATED TIP (FENESTRATED WITH TOOTH) - INNER TONG - T
52105-104	45 CM - FENESTRATED TIP (FENESTRATED WITH TOOTH) - INNER TONG - T

Note:

Both the syringe and scissor handle Kleppinger forceps are available with the optional inner tongs. Use the first number from above for the instrument and add the letter of your choice for the optional insert S, T, M.

We also have reusable replacement tongs available for Storz, ACMI, Pilling and other brands of bipolar laparoscopic forceps



Kleppinger Type III Bipolar Laparoscopic Forceps

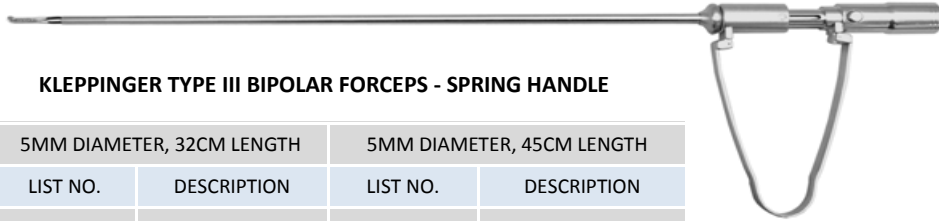

KLEPPINGER TYPE III BIPOLAR FORCEPS - SPRING HANDLE

5MM DIAMETER, 32CM LENGTH		5MM DIAMETER, 45CM LENGTH	
LIST NO.	DESCRIPTION	LIST NO.	DESCRIPTION
52205-85S	STANDARD TIP	52105-67S	STANDARD TIP
52205-85F	FLAT TIP	52105-67F	FLAT TIP
52205-85M	MICRO TIP	52105-67M	MICRO TIP

Features:

- Micro Polished Tip
- Stationary Inner Tong - it does not move in & out while opening & closing, giving the surgeon complete control of placement
- New type of cable connector for easier cleaning of handle & positive connection
 - Interchangeable inner tongs
- Pressure-loaded mechanism of the spring handle assists in closing of the Instrument

Bipolar Cables For Use With Type III Kleppinger Forceps



TYPE III KLEPPINGER PLUG & DUAL-BANANA GENERATOR PLUG
LIST NO. 52005-20

OR



TYPE III KLEPPINGER PLUG & WOLF GENERATOR PLUG
LIST NO. 52005-19

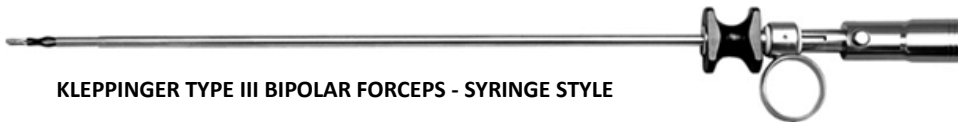

KLEPPINGER TYPE III BIPOLAR FORCEPS - SYRINGE STYLE

5MM DIAMETER, 32CM LENGTH		5MM DIAMETER, 45CM LENGTH	
LIST NO.	DESCRIPTION	LIST NO.	DESCRIPTION
52205-96S	STANDARD TIP	52105-68S	STANDARD TIP
52205-96F	FLAT TIP	52105-68F	FLAT TIP
52205-96M	MICRO TIP	52105-68M	MICRO TIP

Features:

- Micro Polished Tip
- Stationary Inner Tong
- Interchangeable inner tongs
- Jaws close with closing of hand action, giving the surgeon complete control of how much pressure is exerted on the tissue

Reusable Replacement Tongs For Kleppinger Type III

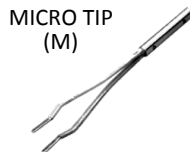
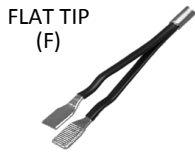
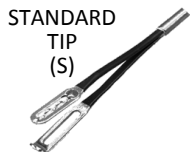

STANDARD TIP FOR SECURE SLIP-FREE GRIP		FLAT TIP, CONVENTIONAL KLEPPINGER STYLE		MICRO TIP FOR PRECISE, PIN-POINT COAGULATION	
32CM	45CM	32CM	45CM	32CM	45CM
52205-44	52105-70	52205-91	52105-71	52205-47	52105-72

Note:

When ordering replacement tongs for Slide Handle Bipolar Forceps with a single tube or with irrigation tube, add letters "ST" to the above List Numbers (the price remains the same). For handle replacement parts for all Laparoscopic Bipolar Forceps refer to the operating instructions.



Kleppinger Type II Bipolar Laparoscopic Forceps



KLEPPINGER TYPE II BIPOLAR FORCEPS - SLIDE HANDLE

5MM DIAMETER, 32CM LENGTH		5MM DIAMETER, 45CM LENGTH	
LIST NO.	DESCRIPTION	LIST NO.	DESCRIPTION
52205-43S	STANDARD TIP	52105-64S	STANDARD TIP
52205-43F	FLAT TIP	52105-64F	FLAT TIP
52205-43M	MICRO TIP	52105-64M	MICRO TIP

Features:

- Micro Polished Tip
- Stationary Inner Tong
- Interchangeable inner tongs
- Opening & closing of the jaw is controlled by sliding the handle back & forward, giving the surgeon complete control of how much pressure is exerted on the tissue

Bipolar Cables For Use With Type II Kleppinger Forceps



TYPE II KLEPPINGER PLUG & DUAL-BANANA GENERATOR PLUG

LIST NO. 52005-22

OR



Infinty TYPE II KLEPPINGER PLUG & Infinty / WOLF GENERATOR PLUG

LIST NO. 52005-21



CLASSIC BIPOLAR FORCEPS - SLIDE HANDLE

5MM DIAMETER, 32CM LENGTH		5MM DIAMETER, 45CM LENGTH	
LIST NO.	DESCRIPTION	LIST NO.	DESCRIPTION
52205-50	MICRO JAW	52105-37	MICRO JAW
52205-41	HOOK JAW	52105-38	HOOK JAW

Features:



Reusable Replacement Tongs For Kleppinger Type III

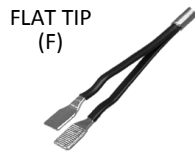
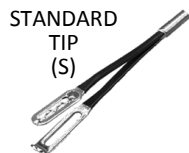

STANDARD TIP FOR SECURE SLIP-FREE GRIP		FLAT TIP, CONVENTIONAL KLEPPINGER STYLE		MICRO TIP FOR PRECISE, PIN-POINT COAGULATION	
32CM	45CM	32CM	45CM	32CM	45CM
52205-44	52105-70	52205-91	52105-71	52205-47	52105-72

Note:

When ordering replacement tongs for Slide Handle Bipolar Forceps with a single tube or with irrigation tube, add letters "ST" to the above List Numbers (the price remains the same). For handle replacement parts for all Laparoscopic Bipolar Forceps refer to the operating instructions.



Powergrip Bipolar Scissors & Forceps

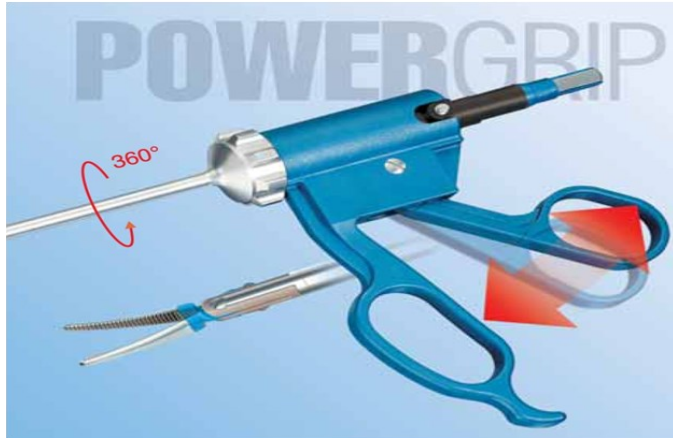

Features:

-The bipolar POWERGRIP coagulation forceps is an instrument used for grasping, cutting and bipolar coagulation in minimally invasive surgery. Their mechanism enables active and precise opening and closing of the jaws as well as applying very high pressure when grasping and cutting while precisely coagulating the tissue. Electrode inserts for different applications can be exchanged within a few seconds

-3-piece take apart for efficient cleaning and interchange of inserts.

-The plug for standardized bipolar cables, which enables the connection to nearly all common high frequency generators, is integrated in the particularly ergonomic handle.

-Reusable instrument and bipolar cable for cost containment.



LIST NO. 52205-510
5MM, 34CM SCISSORS, CURVED



LIST NO. 52205-524
5MM, 34CM GRASPING FORCEPS W/ 2X3 TEETH



LIST NO. 52205-521
5MM, 34CM LARGE GRASPING FORCEPS



LIST NO. 52205-516
5MM, 34CM MARYLAND DISSECTOR, CURVED



LIST NO. 52205-522
5MM, 34CM FORCEPS, CURVED



LIST NO. 52205-520
5MM, 34CM GRASPING FORCEPS, CURVED



LIST NO. 52205-523
5MM, 34CM DELTA GRASPER

Bipolar Cables For Use With InfinityBipolar Powergrip Forceps & Scissors



TYPE II KLEPPINGER PLUG & DUAL-BANANA GENERATOR PLUG
LIST NO. 52005-22



TYPE II KLEPPINGER PLUG & INFI-NITY/WOLF GENERATOR PLUG
LIST NO. 52005-21

OR



360° Rotatable Orbitaris Bipolar Scissors & Forceps

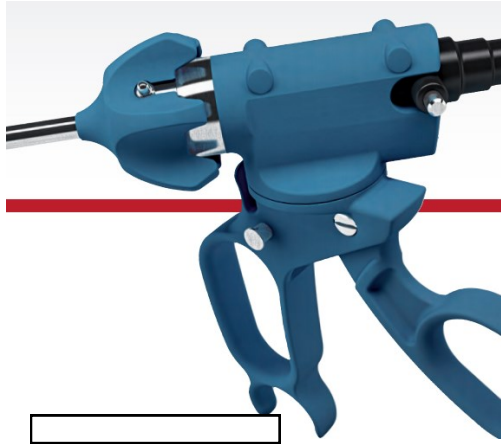

Features:

- The handle can be rotated through 360°, so the surgeons ideal ergonomic handling position can be achieved. The surgeon and patient requirement for function and safety has been greatly enhanced, over standard handles, to include surgeon comfort during the demands of minimally invasive surgery.
- 3-piece take apart for efficient cleaning and interchange of inserts.
- The plug for standardized bipolar cables, which enables the connection to nearly all common high frequency generators, is integrated in the particularly ergonomic handle.
- Reusable instrument and bipolar cable for cost containment.



LIST NO. 52205-010
5MM, 34CM SCISSORS, CURVED



LIST NO. 52205-024
5MM, 34CM GRASPING FORCEPS W/ 2X3 TEETH



LIST NO. 52205-021
5MM, 34CM LARGE GRASPING FORCEPS



LIST NO. 52205-016
5MM, 34CM MARYLAND DISSECTOR, CURVED



LIST NO. 52205-022
5MM, 34CM FORCEPS, CURVED



LIST NO. 52205-020
5MM, 34CM GRASPING FORCEPS, CURVED



LIST NO. 52205-023
5MM, 34CM DELTA GRASPER

Bipolar Cables For Use With Bipolar Powergrip Forceps & Scissors



TYPE II KLEPPINGER PLUG & DUAL-BANANA GENERATOR PLUG

LIST NO. 52005-22

OR



TYPE II KLEPPINGER PLUG & / WOLF GENERATOR PLUG

LIST NO. 52005-21



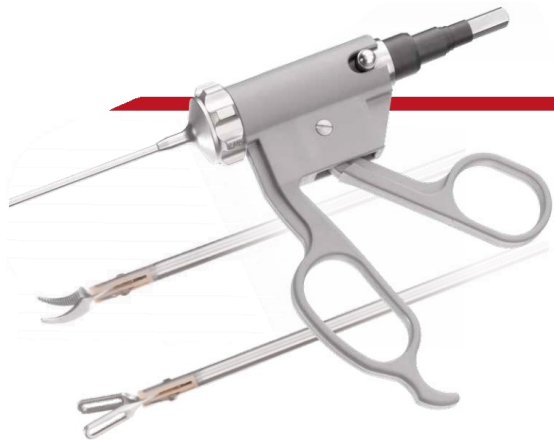

Powergrip 3.0mm Bipolar Dissector & Grasper

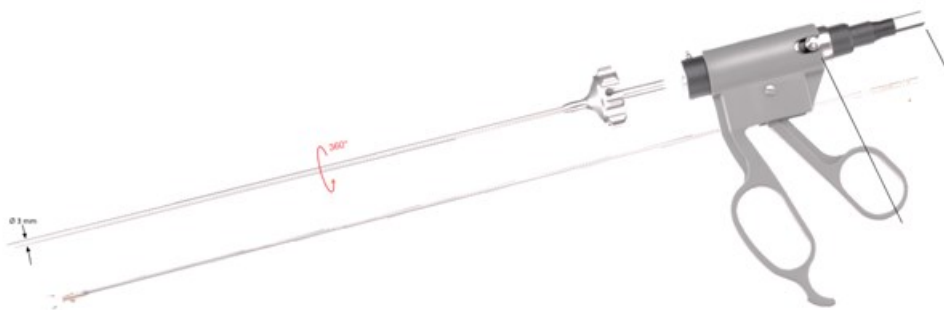

Features:

- Powergrip 3.0 micro - bipolar coagulation forceps 0 3mm Offer all benefits of the tried and tested Powergrip coagulation pliers, but entice with their shaft diameter of only 3 mm
- 3-piece take apart for efficient cleaning and interchange of inserts.
- The plug for standardized bipolar cables, which enables the connection to nearly all common high frequency generators, is integrated in the particularly ergonomic handle.
- Reusable instrument and bipolar cable for cost containment.



TIP ID.	DIAMETER	LENGTH	INSERT NO.	HANDLE NO.	SHAFT NO.	COMPLETE INSTRUMENT
 MARYLAND DISSECTOR, CURVED	3MM	20CM	53020-322I	52203-152	52203-204	53020-322
	3MM	29CM	53029-302I	52203-152	52203-202	53029-302
 FENESTRATED GRASPING FORCEPS	3MM	20CM	53020-320I	52203-152	52203-204	53020-320
	3MM	29CM	53029-300I	52203-152	52203-202	53029-300

Bipolar Cables For Use With AMERISURG Bipolar Dissector & Grasper



TYPE II KLEPPINGER PLUG & DUAL-BANANA GENERATOR PLUG
LIST NO. 52005-22

OR



TYPE II KLEPPINGER PLUG & WOLF GENERATOR PLUG
LIST NO. 52005-21



Classic Bipolar Scissors & Forceps

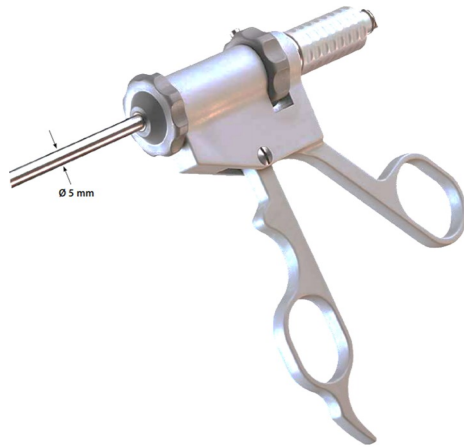

Features:

-The bipolar coagulation forceps which can be dismantled is a reusable instrument to be used for laparoscopy for grasping and cutting the tissue with simultaneous bipolar coagulation. The easy dismantling enables the use of different electrodes, facilitates cleaning and the execution of repair work. By using an adapter, the forceps can be connected with bipolar standard forceps cables to nearly all common high-frequency generators.

-3-piece take apart for efficient cleaning and interchange of inserts.

-The plug for standardized bipolar cables, which enables the connection to nearly all common high frequency generators, is integrated in the particularly ergonomic handle.

-Reusable instrument and bipolar cable for cost containment.

ELECTRODES	DIAMETER	LENGTH	INSERT NO.	HANDLE NO.	INTERIOR TUBE	EXTERIOR TUBE	2-PIN PLUG	COMPLETE INSTRUMENT
 FENESTRATED GRASPER W/ WAVE	5MM	20CM	55020-060I	52000-00	55020-051	55020-052	52000-401	55020-060
	5MM	34CM	55034-010I		55034-002	55034-003		55034-010
	5MM	45CM	55045-020I		55045-006	55045-007		55045-020
 FLUTED TIP, 1MM	5MM	20CM	55020-061I	52000-00	55020-051	55020-052	52000-401	55020-061
	5MM	34CM	55034-011I		55034-002	55034-003		55034-011
	5MM	45CM	55045-021I		55045-006	55045-007		55045-021
 KLEPPINGER, SERRATED	5MM	20CM	55020-063I	52000-00	55020-051	55020-052	52000-401	55020-063
	5MM	34CM	55034-013I		55034-002	55034-003		55034-013
	5MM	45CM	55045-023I		55045-006	55045-007		55045-023
 TONG-TYPE BIT, 3MM	5MM	20CM	55020-065I	52000-00	55020-051	55020-052	52000-401	55020-065
	5MM	34CM	55034-015I		55034-002	55034-003		55034-015
	5MM	45CM	55045-025I		55045-006	55045-007		55045-025
 SCISSORS, CURVED	5MM	20CM	55020-067I	52000-00	55020-051	55020-052	52000-401	55020-067
	5MM	34CM	55034-017I		55034-002	55034-003		55034-017
	5MM	45CM	55045-027I		55045-006	55045-007		55045-027
 SCISSORS W/ TC BLADE CURVED	5MM	20CM	55020-068I	52000-00	55020-051	55020-052	52000-401	55020-068
	5MM	34CM	55034-018I		55034-002	55034-003		55034-018
	5MM	45CM	55045-028I		55045-006	55045-007		55045-028
 MARYLAND DISSCETOR, CURVED	5MM	20CM	55020-069I	52000-00	55020-051	55020-052	52000-401	55020-069
	5MM	34CM	55034-019I		55034-002	55034-003		55034-019
	5MM	45CM	55045-029I		55045-006	55045-007		55045-029

TYPE II KLEPPINGER PLUG & / WOLF GENERATOR PLUG

LIST NO. 52005-45

Bipolar Cables For Use With Bipolar Dissector & Grasper

TYPE II KLEPPINGER PLUG & DUAL-BANANA GENERATOR PLUG

LIST NO. 52005-46



Triple Function Forceps

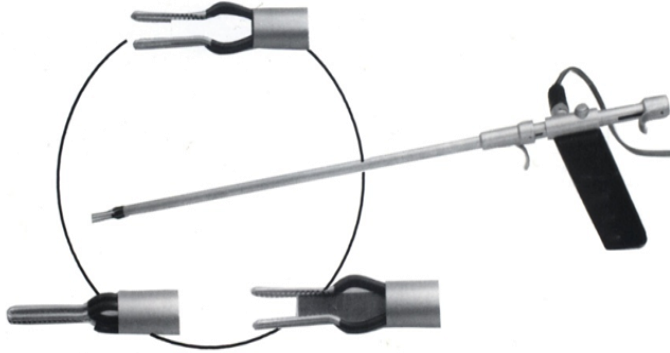

The Most Effective Multipurpose Instrument of Its Kind, With Features Such As:

- **Multiple Functions** - Securely Grasp / Dissect Tissue / Safely Coagulate in the Bipolar Mode / Transect Tissue / Retract Tissue
- **Reusability** - easy, cost effective cleaning & maintenance
- Eliminating costly stapling devices
- One instrument, One insertion
- Reducing procedure time

Bipolar Cables For Use With Bipolar Triple Function Forceps

LIST NO.	DESCRIPTION
52510-00	BIPOLAR TRIPLE FUNCTION FORCEPS: 30 CM LONG, 10 MM
52510-00-01	COMPLETE INNER SHAFT ASSEMBLY WITH BLADE
52510-00-02	BLADE ASSEMBLY FOR TRIPLE FUNCTION FORCEPS

LIST NO.	DESCRIPTION
52005-80	BIPOLAR RF-CABLE FOR BIPOLAR TRIPLE FUNCTION FORCEPS AND / WOLF GENERATORS
52005-81	BIPOLAR RF-CABLE FOR BIPOLAR TRIPLE FUNCTION FORCEPS AND MACHINE WITH TWO BANANA-PLUG CONNECTION

Bipolar Coagulation Probes



LIST NO.	DESCRIPTION
52103-35	3MM, 33CM BIPOLAR SPOT COAGULATION PROBE
52203-35	3MM, 45CM BIPOLAR SPOT COAGULATION PROBE
52205-42	5MM, 33CM BIPOLAR SPOT COAGULATION PROBE
52105-37	5MM, 45CM BIPOLAR SPOT COAGULATION PROBE

LIST NO.	DESCRIPTION
52005-99	5MM, 33CM BIPOLAR MYOMA COAGULATOR
52005-98	5MM, 45CM BIPOLAR MYOMA COAGULATOR
52005-97	5MM, 33CM BIPOLAR MYOMA COAGULATOR W/ TRUMPET VALVE
52005-96	5MM, 45CM BIPOLAR MYOMA COAGULATOR W/ TRUMPET VALVE

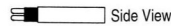

LIST NO.	DESCRIPTION
52205-92	5MM, 33CM BIPOLAR PROBE, TWO BLUNT PRONGS
52205-93	5MM, 33CM BIPOLAR PROBE, TWO BLUNT PRONGS W/ TRUMPET VALVE

Bipolar Cables For Use With Bipolar Coagulation Probes



LIST NO. 52005-22
TYPE II KLEPPINGER PLUG & DUAL-BANANA GENERATOR PLUG

OR



LIST NO. 52005-21
TYPE II KLEPPINGER PLUG & / WOLF GENERATOR PLUG



Amerisurg Bi-Pol Cutter

The Amerisurg Bi-Pol Cutter consists of a fully insulated bipolar system w/ a retractable needle. When surgery is to be performed, the needle is advanced up to 4mm, depending on the depth of the desired cut. The end of the electrode, which has a ball-type shape, serves as the “return” electrode.

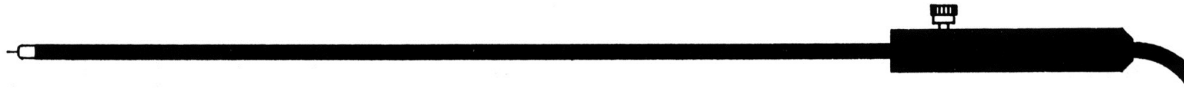

LIST NO.	DESCRIPTION
52205-90	5MM, 33CM BI-POL CUTTER
52105-90	5MM, 45CM BI-POL CUTTER

Bipolar J-Hook, L-Hook & Spatula Electrodes

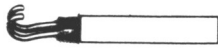

J-HOOK

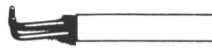

L-HOOK



SPATULA

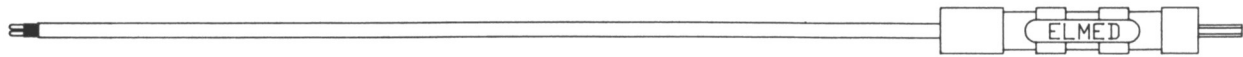

LIST NO.	DESCRIPTION
52205-120	5MM, 33CM BIPOLAR J-HOOK ELECTRODE
52205-121	5MM, 33CM BIPOLAR J-HOOK ELECTRODE W/ TRUMPET VALVE FOR IRRIGATION
52205-122	5MM, 33CM BIPOLAR L-HOOK ELECTRODE
52205-123	5MM, 33CM BIPOLAR L-HOOK ELECTRODE W/ TRUMPET VALVE FOR IRRIGATION
52205-124	5MM, 33CM BIPOLAR SPATULA ELECTRODE
52205-125	5MM, 33CM BIPOLAR SPATULA ELECTRODE W/ TRUMPET VALVE FOR IRRIGATION

LIST NO.	DESCRIPTION
52105-120	5MM, 45CM BIPOLAR J-HOOK ELECTRODE
52105-121	5MM, 45CM BIPOLAR J-HOOK ELECTRODE W/ TRUMPET VALVE FOR IRRIGATION
52105-122	5MM, 45CM BIPOLAR L-HOOK ELECTRODE
52105-123	5MM, 45CM BIPOLAR L-HOOK ELECTRODE W/ TRUMPET VALVE FOR IRRIGATION
52105-124	5MM, 45CM BIPOLAR SPATULA ELECTRODE
52105-125	5MM, 45CM BIPOLAR SPATULA ELECTRODE W/ TRUMPET VALVE FOR IRRIGATION

Bipolar Cables For Use With Amerisurg Bipolar Coagulation Probes



LIST NO. 52005-22

TYPE II KLEPPINGER PLUG & DUAL-BANANA GENERATOR PLUG

OR



LIST NO. 52005-21

AMERISURG TYPE II KLEPPINGER PLUG & AMERISURG / WOLF GENERATOR PLUG



Reusable Cables For Bipolar Instruments & Generators



WOLF GENERATOR END



DUAL-BANANNA PLUG GENERATOR END

LIST NO. 52005-21 / 5302	AMERISURG/WOLF PLUG (UNIT)& AMERISURG (DIN) INSTRUMENT PLUG
LIST NO. 52005-19	AMERISURG/WOLF PLUG (UNIT) & AMERISURG TYPE III
LIST NO. 52005-23	AMERISURG/WOLF UNIT PLUG & WOLF INST. PLUG
LIST NO. 52005-25	AMERISURG/WOLF PLUG (UNIT) & STORZ/WISAP/JARIT METAL INST.
LIST NO. 52005-17	AMERISURG/WOLF PLUG (UNIT) & STORZ/WISAP BARREL STYLE INST.
LIST NO. 52005-39	AMERISURG/WOLF PLUG (UNIT) & KLI/CIRCON INST.
LIST NO. 52005-41	AMERISURG/WOLF PLUG (UNIT) & EVEREST/COBALT
LIST NO. 52005-43	AMERISURG/WOLF PLUG (UNIT) & DAVOL INST. PLUG
LIST NO. 52005-45 / 5991	AMERISURG/WOLF PLUG (UNIT) & AESCULAP/DAVOL/MARINA 2-PIN INST. PLUG
LIST NO. 52005-60	AMERISURG/WOLF PLUG (UNIT) & LINVATEC/WECK/PILLING INST. PLUG
LIST NO. 52005-91	AMERISURG/WOLF PLUG (UNIT) & JARIT, ERBE INST.
LIST NO. 52005-13	AMERISURG/WOLF PLUG (UNIT) & IAMERISURG BI-CUT SCISSORS

INSTRUMENT END



LIST NO. 52005-22 / 5230	DUAL-BANANA PLUG (UNIT) & AMERISURG(DIN) INSTRUMENT PLUG
LIST NO. 52005-20	DUAL-BANANA PLUG (UNIT) & AMERISURG TYPE III INST.
LIST NO. 52005-24	DUAL-BANANA PLUG (UNIT) & WOLF INST. PLUG
LIST NO. 52005-26	DUAL-BANANA PLUG (UNIT) & STORZ/WISAP/JARIT METAL PLUG
LIST NO. 52005-18	DUAL-BANANA PLUG (UNIT) & STORZ/WISAP BARREL STYLE INST. PLUG
LIST NO. 52005-40	DUAL-BANANA PLUG (UNIT) & KLI/CIRCON INST. PLUG
LIST NO. 52005-42	DUAL-BANANA PLUG (UNIT) & EVEREST/COBALT INST. PLUG
LIST NO. 52005-44	DUAL-BANANA PLUG (UNIT) & DAVOL INST. PLUG
LIST NO. 52005-46 / 5990	DUAL-BANANA PLUG (UNIT) & AESCULAP/DAVOL/MARINA 2-PIN INST. PLUG
LIST NO. 52005-61	DUAL-BANANA PLUG (UNIT) & LINVATEC/WECK/PILLING INST. PLUG
LIST NO. 52005-92	DUAL-BANANA PLUG (UNIT) & JARIT, ERBE INST. PLUG
LIST NO. 52005-14	DUAL-BANANA PLUG (UNIT) & AMERISURG BI-CUT SCISSORS

BIPOLAR CABLE ADAPTERS



LIST NO. 5352	ADAPTER FOR AMERISURG / WOLF GENERATOR PLUG & 4MM FEMALE BANANA CABLE PLUGS
------------------	--



LIST NO. 52005-83	ADAPTER FOR DUAL MALE BANA-NA GENERATOR PLUGS & AMERISURG / WOLF RECEPTACLE PLUG
----------------------	---











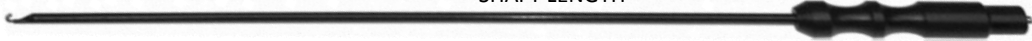

LIST NO. 52005-84	ADAPTER FOR DUAL MALE BANANA GENERATOR PLUGS & WOLF KLEPPINGER FORCEPS PLUG
----------------------	---



5mm Diameter Monopolar Electrodes

32CM OR 45CM
SHAFT LENGTH

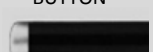

ELECTRODES	DIAMETER	LENGTH	<u>SIDE MOUNTED RF CONNECTOR</u>	<u>REAR MOUNTED RF CONNECTOR</u>
				
 J-HOOK	5MM	33CM	52205-38	52205-81
	5MM	45CM	52105-33	52105-81
 L-HOOK	5MM	33CM	52205-78	52205-82
	5MM	45CM	52105-35	52105-82
 SPATULA	5MM	33CM	52205-56	52205-83
	5MM	45CM	52105-46	52105-83
 CONE	5MM	33CM	52205-36	52205-88
	5MM	45CM	52105-31	52105-88
 BALL	5MM	33CM	52205-07	52205-89
	5MM	45CM	52105-07	52105-89
 KNIFE	5MM	33CM	52205-35	52205-90
	5MM	45CM	52105-30	52105-90
 NEEDLE	5MM	33CM	52205-37	52205-76
	5MM	45CM	52105-45	52105-74
 BUTTON	5MM	33CM	52205-37	52205-37R
	5MM	45CM	52105-02	52105-02R

Monopolar Cables For Use With Electrodes



LIST NO. 52005-31
4MM DIA. PLUG (UNIT) &
4MM DIA. FEMALE INST. PLUG



LIST NO. 52005-32
8MM DIA. "BOVIE" PLUG (UNIT) &
4MM DIA. FEMALE INST. PLUG



**5mm Diameter Monopolar Electrodes-
With Suction/Irrigation Port**

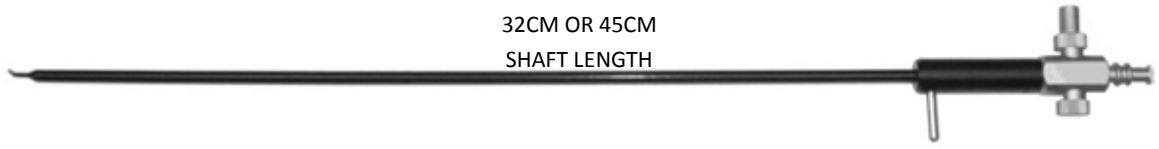

HANDLE STYLES	DIAMETER	LENGTH	J-HOOK	L-HOOK	SPATULA	CONE	SLING	KNIFE	NEEDLE	SUCTION TIP
WITH LUER LOCK 	5MM	33CM	52205-57L	52205-72L	52205-58L	52205-77L	52205-66L	52205-65L	52205-74L	52205-28L
	5MM	45CM	52105-48L	52105-56L	52105-58L	52105-58L	52105-48L	52105-47L	52105-74L	52105-28L
WITH STOPCOCK 	5MM	33CM	52205-57	52205-72	52205-58	52205-77	52205-66	52205-65	52205-74S	52205-27
	5MM	45CM	52105-48	52105-56	52105-58	52105-58	52105-48	52105-47	52105-74S	52105-24
WITH TRUMPET VALVE 	5MM	33CM	52205-63	52205-73	52205-64	52205-84	52205-68	52205-67	52205-74T	52205-26
	5MM	45CM	52105-54	52105-57	52105-50	52105-60	52105-52	52105-51	52105-74T	52105-23



LIST NO. 52005-31
4MM DIA. PLUG (UNIT) &
4MM DIA. FEMALE INST. PLUG

Monopolar Cables For Use With Electrodes



LIST NO. 52005-32
8MM DIA. "BOVIE" PLUG (UNIT) &
4MM DIA. FEMALE INST. PLUG

5mm Diameter Monopolar Electrodes - For Use W/ Hand-Switching Handles



"J" HOOK

33CM	LIST NO. 52850-81
36CM	LIST NO. 52836-81
45CM	LIST NO. 52815-81



"L" HOOK

33CM	LIST NO. 52850-82
36CM	LIST NO. 52836-82
45CM	LIST NO. 52815-82



SPATULA

33CM	LIST NO. 52850-83
36CM	LIST NO. 52836-83
45CM	LIST NO. 52815-83



CONE

33CM	LIST NO. 52850-84
36CM	LIST NO. 52836-84
45CM	LIST NO. 52815-84



BALL

33CM	LIST NO. 52850-85
36CM	LIST NO. 52836-85
45CM	LIST NO. 52815-85



KNIFE

33CM	LIST NO. 52850-86
36CM	LIST NO. 52836-86
45CM	LIST NO. 52815-86



NEEDLE

33CM	LIST NO. 52850-87
36CM	LIST NO. 52836-87
45CM	LIST NO. 52815-87



BUTTON

33CM	LIST NO. 52850-88
36CM	LIST NO. 52836-88
45CM	LIST NO. 52815-88

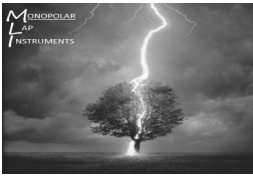

Reusable Cables For Monopolar Instruments & Generators



4MM "BANANA" GENERATOR END



8MM "BOVIE" GENERATOR END

INSTRUMENT END

LIST NO. 5021	4MM DIA. MALE INST. PLUG
LIST NO. 5022	OLSEN TYPE SCREW-ON INST. PLUG
LIST NO. 5029	OLYMPUS TYPE INST. PLUG
LIST NO. 5260	ACMI TYPE INST. PLUG
LIST NO. 5268	TAPERED "DOWNS" TYPE INST. PLUG
LIST NO. 52005-29	3MM DIA. FEMALE INST. PLUG
LIST NO. 52005-31	4MM DIA. FEMALE INST. PLUG
LIST NO. 52005-35	CORSON NEEDLE ELECTRODE INST. PLU
LIST NO. 52005-37	DUAL STAGE MALE (STORZ) INST. PLUG
LIST NO. 52005-47	RESECTOSCOPE INST. PLUG
LIST NO. 52005-49	4MM DIA. RECESSED PIN (WOLF/CORSON/STORZ) INST. PLUG
LIST NO. 52005-69	4MM DIA. SELF-RETAINING PLUG FOR STORZ SOLID POST INST.
LIST NO. 52005-71	4MM DIA. INSULATED OUTER SLEEVE PLUG FOR V.MUELLER INST
LIST NO. 52005-73	4MM DIA. EXTRA-LONG PLUG & 4MM DIA. EXTRA-LONG PLUG: STORZ INST.
LIST NO. 52005-75	4MM DIA. RIGHT ANGLE FEMALE INST. PLUG.
LIST NO. 52005-77	MALE LUER LOCK INST. PLUG
LIST NO. 52005-53	3MM DIA RECESSED POST PLUG FOR OLYMPUS RESECTOSCOPE
LIST NO. 5025	SCREW ON CODMAN TYPE PLUG



LIST NO. 5009	4MM DIA. MALE INST. PLUG
LIST NO. 5023	OLSEN TYPE SCREW-ON INST. PLUG
LIST NO. 5030	OLYMPUS TYPE INST. PLUG
LIST NO. 5261	ACMI TYPE INST. PLUG
LIST NO. 5269	TAPERED "DOWNS" TYPE INST. PLUG
LIST NO. 52005-30	3MM DIA. FEMALE INST. PLUG
LIST NO. 52005-32	4MM DIA. FEMALE INST. PLUG
LIST NO. 52005-36	CORSON NEEDLE ELECTRODE INST. PLU
LIST NO. 52005-38	DUAL STAGE MALE (STORZ) INST. PLUG
LIST NO. 52005-48	RESECTOSCOPE INST. PLUG
LIST NO. 52005-50	4MM DIA. RECESSED PIN (WOLF/CORSON/STORZ) INST. PLUG
LIST NO. 52005-70	4MM DIA. SELF-RETAINING PLUG FOR STORZ SOLID POST INST.
LIST NO. 52005-72	4MM DIA. INSULATED OUTER SLEEVE PLUG FOR V.MUELLER INST
LIST NO. 52005-74	4MM DIA. EXTRA-LONG PLUG & 4MM DIA. EXTRA-LONG PLUG: STORZ INST.
LIST NO. 52005-76	4MM DIA. RIGHT ANGLE FEMALE INST. PLUG.
LIST NO. 52005-78	MALE LUER LOCK INST. PLUG
LIST NO. 52005-54	3MM DIA RECESSED POST PLUG FOR OLYMPUS RESECTOSCOPE
LIST NO. 5026	SCREW ON CODMAN TYPE PLUG

MONOPOLAR CABLE ADAPTERS



LIST NO. 5414
ADAPTER FOR MALE "BOVIE" GENERATOR PLUG & 4MM FEMALE BANANA CABLE PLUG



LIST NO. 5415
ADAPTER FOR MALE "BOVIE" GENERATOR PLUG & DISPOSABLE INSTRUMENT PLUG



LIST NO. 5416
ADAPTER FOR MALE BANANA GENERATOR PLUG & DISPOSABLE INSTRUMENT PLUG



Irrigation / Suction Tubes

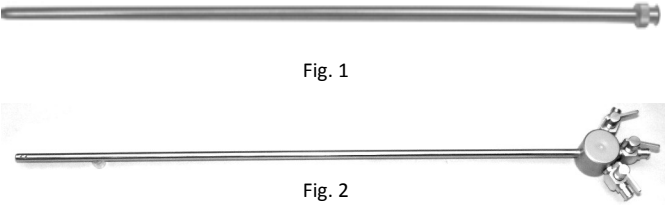

LIST NO. 52205-30	IRRIGATION / SUCTION TUBE w/ LUER FITTING, 33cm, 5mm DIA. -- Fig. 1
LIST NO. 52105-26	IRRIGATION / SUCTION TUBE w/ LUER FITTING, 45cm, 5mm DIA.
LIST NO. 52205-32	IRRIGATION / SUCTION PROBE w/ CM MARKINGS & STOPCOCK, 33cm, 5mm DIA.
LIST NO. 52105-28	IRRIGATION / SUCTION PROBE w/ CM MARKINGS & STOPCOCK, 45cm, 5mm DIA.
LIST NO. 52205-32T	IRRIGATION / SUCTION PROBE w/ CM MARKINGS & TRUMPET VALVE, 33cm, 5mm DIA.
LIST NO. 52105-28T	IRRIGATION / SUCTION PROBE w/ CM MARKINGS & TRUMPET VALVE, 45cm, 5mm DIA.
LIST NO. 52205-33	LAVAGE CANNULA w/ 3-WAY STOPCOCK, POOLE SUCTION TIP w/ LATERAL HOLES, 33cm, 5mm DIA.-- Fig. 2
LIST NO. 52105-33	LAVAGE CANNULA w/ 3-WAY STOPCOCK, POOLE SUCTION TIP w/ LATERAL HOLES, 45cm, 5mm DIA.

Irrigation / Suction Systems

EXTRA LARGE SUCTION PORTS

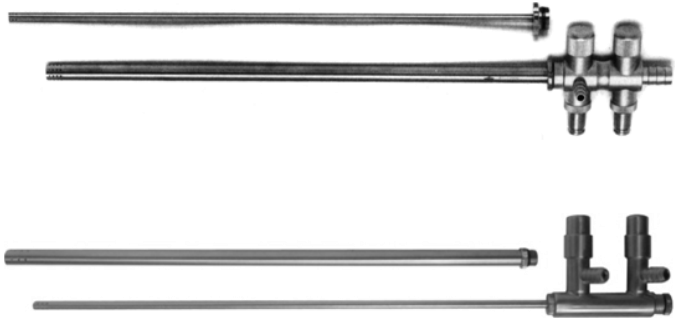

LIST NO. 52500-15	IRRIGATION / SUCTION SYSTEM W/ DUAL-VALVE HANDLE, COMPLETE W/ 33CM, 10MM & 5MM DIAMETER CANNULA
LIST NO. 52500-30	IRRIGATION / SUCTION SYSTEM W/ DOUBLE "O" RING TRUMPET VALVE HANDLE, W/ INSTRUMENT CHANNEL, COMPLETE W/ 33CM, 10MM & 5MM DIA. CANNULA
LIST NO. 52500-31	IRRIGATION / SUCTION SYSTEM W/ DOUBLE "O" RING TRUMPET VALVE HANDLE, W/ INSTRUMENT CHANNEL, COMPLETE W/ 45CM, 10MM & 5MM DIA. CANNULA

TWO-WAY VALVE IRRIGATION/SUCTION SYSTEM



LIST NO. 52500-25	5MM, 33CM IRRIGATION / SUCTION SYSTEM W/ TWO-WAY LEVER VALVE, CANNULA W/ CENTRAL & LATERAL DISTAL OPENINGS
LIST NO. 52500-26	5MM, 45CM, IRRIGATION / SUCTION SYSTEM W/ TWO-WAY LEVER VALVE, CANNULA W/ CENTRAL & LATERAL DISTAL OPENINGS



Irrigation / Suction Tubes

NETZHAT STYLE IRRIGATION/SUCTION SYSTEM



LIST NO. 52500-16	NETZHAT STYLE IRRIGATION / SUCTION SYSTEM W/ DUAL TRUMPET VALVE HANDLE, COMPLETE W/ 33CM, 10MM & 5MM DIAMETER CANNULA
----------------------	---

CORSON STYLE IRRIGATION/SUCTION SYSTEM



LIST NO. 52205-94	CORSON STYLE IRRIGATION / SUCTION SYSTEM (NOT INCLUDING NEEDLE ELECTRODE), W/ 33CM, 5MM DIAMETER CANNULA
LIST NO. 52205-95	CORSON STYLE NEEDLE ELECTRODE FOR CANNULA
LIST NO. 52003-13	SEALING CAP FOR CORSON STYLE CANNULA, (PKG. OF 10)

Monopolar Cables For Use With Corson Style Irrigation / Suction System



LIST NO. 52005-35
4MM DIA. PLUG & CORSON NEEDLE ELECTRODE INST. PLUG



LIST NO. 52005-36
8MM DIA. "BOVIE" PLUG & CORSON NEEDLE ELECTRODE INST. PLUG



Triple Function Suction / Irrigation Cannula

Our special Triple Function Irrigation / Suction instruments feature interchangeable cannula and will accept standard instruments through their center allowing three functions through one portal. The instruments consist of unique handles, List No. 52500-10 and 52500-11, incorporating two trumpet valves with 7mm diameter ports, one controls the suction, the other one controls the irrigation. The 7mm diameter ports and perfect seal trumpet valve provide a greater flow volume, no clogging and perfect sealing, thus preventing the irrigation fluid from leaking into the instrument. These handles and their respective cannula will accept standard diameter laparoscopic and pelviscopic instruments. These Irrigation / Suction Cannula are ideally suited for use with the new AMERISURG or other brands of laparoscopic electrosurgical instruments. A variety of different cannula are available for the irrigation/suction handle. These cannula will fit through all standard 10mm and 5mm diameter trocar sleeves and are available in both 33cm and 45cm lengths. Poole suction tip cannula are available – see below.

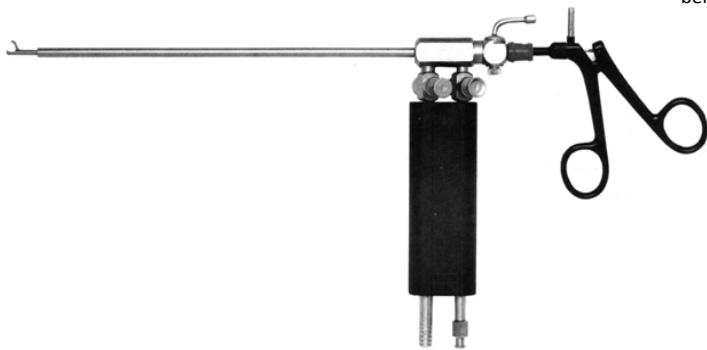

LIST NO. 52500-10	McLUCAS TRIPLE-FUNCTION HANDLE, COMPLETE w/ 33cm, 5mm DIAMETER CANNULA (Illustrated w/ an instrument inserted through its center)
----------------------	---

TECHNICAL & ORDERING DATA FOR McLUCAS & AMERISUG TRIPLE-FUNCTION CANNULA COMPLETE SYSTEMS

LIST NO. 52500-00	IRRIGATION / SUCTION CANNULA SYSTEM ACCORDING TO BRUCE McLUCAS, M.D., w/ 33cm CANNULA; INCLUDES: LIST NO. 52500-10 HANDLE & LIST NOS. 52510-01 & 52505-21 CANNULA
LIST NO. 52500-01	IRRIGATION / SUCTION CANNULA SYSTEM ACCORDING TO BRUCE McLUCAS, M.D., w/ 45cm CANNULA; INCLUDES: LIST NO. 52500-10 HANDLE & LIST NOS. 52510-03 & 52505-23 CANNULA
LIST NO. 52500-02	IRRIGATION / SUCTION CANNULA SYSTEM, w/ 33cm CANNULA; INCLUDES: LIST NO. 52500-11 HANDLE & LIST NOS. 52510-01 & 52505-21 CANNULA
LIST NO. 52500-03	IRRIGATION / SUCTION CANNULA SYSTEM, w/ 45cm CANNULA; INCLUDES: LIST NO. 52500-11 HANDLE & LIST NOS. 52510-03 & 52505-23 CANNULA

INDIVIDUAL COMPONENTS:



LIST NO. 52500-11	TRIPLE-FUNCTION HANDLE, w/ DUAL TRUMPET VALVES, COMPLETE w/ 33cm, 5mm DIAMETER CANNULA
----------------------	--

LIST NO. 52500-10	MCLUCAS TRIPLE-FUNCTION SUCTION/IRRIGATION LONG HANDLE W/ TWO 7MM DIAMETER TRUMPET VALVES, WITHOUT CANNULA
LIST NO. 52500-11	TRIPLE-FUNCTION SUCTION/IRRIGATION SHORT HANDLE W/ TWO 7MM DIAMETER TRUMPET VALVES, WITHOUT CANNULA
LIST NO. 52505-21	5MM DIA., 33CM LONG CANNULA, (FOR 3MM DIAMETER INSTRUMENTS)
LIST NO. 52505-22	5MM DIA., 33CM LONG SUCTION CANNULA, W/ POOLE SUCTION TIP
LIST NO. 52505-23	5MM DIA., 45CM LONG CANNULA, (FOR 3MM DIAMETER INSTRUMENTS)
LIST NO. 52505-24	5MM DIA., 45CM LONG SUCTION CANNULA, W/ POOLE SUCTION TIP
LIST NO. 52510-01	10MM DIA., 33CM LONG CANNULA, (FOR 3MM DIAMETER INSTRUMENTS)
LIST NO. 52510-02	10MM DIA., 33CM LONG SUCTION CANNULA, 5MM DIA., W/ POOLE SUCTION TIP
LIST NO. 52510-03	10MM DIA., 45CM LONG CANNULA, 5MM DIA. (FOR 3MM DIAMETER INSTRUMENTS)
LIST NO. 52510-04	10MM DIA., 45CM LONG SUCTION CANNULA, 5MM DIA., W/ POOLE SUCTION TIP



Irrigation / Suction Tubes For Disposable Handles



STYLE	DIAMETER	LENGTH	STRYKER™ STYLE	BARD™/DAVOL™ STYLE	CARDINAL HEALTH™ PULSEWAVE™ STYLE	CIRCON™/ACMI™ SURGI-FLEX™ STYLE	COMED™ CORE STYLE
REGULAR TIP- VENTED STAINLESS STEEL FINISH	3MM	20CM	52720-403	52920-403	52420-403	52620-403	52820-403
	3MM	30CM	52730-403	52930-403	52430-403	52630-403	52830-403
	5MM	28CM	52728-403	52928-403	52428-403	52628-403	52828-403
	5MM	32CM	52732-403	52932-403	52432-403	52632-403	52832-403
	5MM	45CM	52745-403	52945-403	52445-403	52645-403	52845-403
	10MM	28CM	52728-404	52928-404	52428-404	52628-404	52828-404
	10MM	32CM	52732-404	52932-404	52432-404	52632-404	52832-404
	10MM	45CM	52745-404	52945-404	52445-404	52645-404	52845-404
REGULAR TIP NON-VENTED REFLECTIVE FINISH	3MM	20CM	52720-409	52920-409	52420-409	52620-409	52820-409
	3MM	30CM	52730-409	52930-409	52430-409	52630-409	52830-409
	5MM	28CM	52728-409	52928-409	52428-409	52628-409	52828-409
	5MM	32CM	52732-409	52932-409	52432-409	52632-409	52832-409
	5MM	45CM	52745-409	52945-409	52445-409	52645-409	52845-409
	10MM	28CM	52728-410	52928-410	52428-410	52628-410	52828-410
	10MM	32CM	52732-410	52932-410	52432-410	52632-410	52832-410
	10MM	45CM	52745-410	52945-410	52445-410	52645-410	52845-410
POOL SUCTION TIP	3MM	20CM	52720-406	52920-406	52420-406	52620-406	52820-406
	3MM	30CM	52730-406	52930-406	52430-406	52630-406	52830-406
	5MM	28CM	52728-406	52928-406	52428-406	52628-406	52828-406
	5MM	32CM	52732-406	52932-406	52432-406	52632-406	52832-406
	5MM	45CM	52745-406	52945-406	52445-406	52645-406	52845-406
	10MM	28CM	52728-405	52928-405	52428-405	52628-405	52828-405
	10MM	32CM	52732-405	52932-405	52432-405	52632-405	52832-405
	10MM	45CM	52745-405	52945-405	52445-405	52645-405	52845-405



Irrigation / Suction Tubes For Disposable Handles



STYLE	DIAMETER	LENGTH	STRYKER™ STYLE	BARD™/DAVOL™ STYLE	CARDINAL HEALTH™ PULSEWAVE™ STYLE	CIRCON™/ACMI™ SURGI-FLEX™ STYLE	COMED™ CORE STYLE
STONE SCOOPER	10MM	32CM	52732-492	52932-492	52432-492	52632-492	52832-492
	10MM	45CM	52745-492	52945-492	52445-492	52645-492	52845-492
HYDRO- DISSECTION TIP	3MM	20CM	52720-407	52920-407	52420-407	52620-407	52820-407
	3MM	30CM	52730-407	52930-407	52430-407	52630-407	52830-407
	5MM	32CM	52732-407	52932-407	52432-407	52632-407	52832-407
	5MM	45CM	52745-407	52945-407	52445-407	52645-407	52845-407
ASPIRATION NEEDLE TIP	3MM	20CM	52720-437	52920-437	52420-437	52620-437	52820-437
	3MM	30CM	52730-437	52930-437	52430-437	52630-437	52830-437
	5MM	32CM	52732-437	52932-437	52432-437	52632-437	52832-437
	5MM	45CM	52745-437	52945-437	52445-437	52645-437	52845-437

OPTIONS FOR STAINLESS STEEL CANNULAS:

- NON-REFLECTIVE FINISH— ADD LETTERS “NR” TO NUMBER
- BLACK EBONIZED FINISH FOR LASER APPLICATION—ADD LETTER “E” TO NUMBER
- CUSTOM WORKING LENGTH—ADD LENGTH TO DESCRIPTION—NON-RETURNABLE



Monopolar RF Electrodes For Disposable Handles

- Double insulated w/ replaceable tip protector sleeve for increased safety
- Quick disconnect for easy cleaning & re-sterilization
- Suction / Irrigation with cutting coagulation

STYLE	DIAMETER	LENGTH	STRYKER™ STYLE	BARD™/DAVOL™ STYLE	CARDINAL HEALTH™ PULSEWAVE™ STYLE	CIRCON™/ACMI™ SURGI-FLEX™ STYLE	COMED™ CORE STYLE
SPATULA TIP	5MM	32CM	52732-441	52932-441	52432-441	52632-441	52832-441
	5MM	45CM	52745-441	52945-441	52445-441	52645-441	52845-441
L-HOOK TIP	5MM	32CM	52732-442	52932-442	52432-442	52632-442	52832-442
	5MM	45CM	52745-442	52945-442	52445-442	52645-442	52845-442
J-HOOK TIP	5MM	32CM	52732-443	52932-443	52432-443	52632-443	52832-443
	5MM	45CM	52745-443	52945-443	52445-443	52645-443	52845-443
NEEDLE TIP	5MM	32CM	52732-444	52932-444	52432-444	52632-444	52832-444
	5MM	45CM	52745-444	52945-444	52445-444	52645-444	52845-444
BALL TIP	5MM	32CM	52732-445	52932-445	52432-445	52632-445	52832-445
	5MM	45CM	52745-445	52945-445	52445-445	52645-445	52845-445
BULLET SUCTION TIP	5MM	32CM	52732-446	52932-446	52432-446	52632-446	52832-446
	5MM	45CM	52745-446	52945-446	52445-446	52645-446	52845-446
PROTECTOR SHEATH-3/PK	5MM	32CM	52732-500	52932-500	52432-500	52632-500	52832-500
	5MM	45CM	52745-500	52945-500	52445-500	52645-500	52845-500



Endo-Test Units For Insulation Testing



1ST GENERATION

ENDO-TEST UNIT - COMPLETE PACKAGE INCLUDES: AUTOCLAVABLE TEST ELECTRODES (INSULATION TEST); 3MM SPONGES (5), 5MM SPONGES (5) & 10MM SPONGES (5); TEST CABLES (INSULATION TEST). *PLEASE SPECIFY CABLE FOR VALLEYLAB UNITS IF REQUIRED – ORDER EXTRA



2ND GENERATION

ENDO-TEST UNIT WITH MONOPOLAR & BIPOLAR CABLE TESTER
CIRCUIT COMPLETE PACKAGE INCLUDES SAME AS #52-5685 PLUS ADAPTERS & CABLE REQUIRED FOR CABLE TEST



3RD GENERATION

ENDO-TEST UNIT WITH MONOPOLAR & BIPOLAR CABLE TESTER CIRCUIT W/ ADVANCED SENSORY DETECTION OF INSULATION DEFECTS: COMPLETE PACKAGE INCLUDES SAME AS #52-5685 PLUS ADAPTERS & CABLE REQUIRED FOR CABLE TEST

ACCESSORIES FOR ENDO-TEST:

LIST NO	DESCRIPTION
52-5685-01	ELECTRODE FOR CAPACITANCE TEST
52-5685-02	ELECTRODE FOR INSULATION TEST
52-5685-03	5 MM SPONGE INSERT FOR INSULATION TEST (10/PKG.)
52-5685-04	10 MM SPONGE INSERT FOR INSULATION TEST (10/PKG.)
52-5685-05	TEST CABLE FOR INSULATION TEST W/ 4 MM FEMALE CONNECTOR
52-5685-06	TEST CABLE FOR CAPACITANCE TEST W/ 1/4" PHONO PLUG
52-5685-07	*TEST CABLE FOR CAPACITANCE TEST FOR VALLEYLAB UNITS
52-5685-08	3 MM SPONGE INSERT FOR INSULATION TEST (10/PKG.)

ACCESSORIES FOR CABLE TESTER:

LIST NO	DESCRIPTION
52-5686-11	BIPOLAR ADAPTER CABLE
52-5686-12	BOVIE PLUG ADAPTER
52-5686-13	BANANA PLUG ADAPTER
52-5686-14	BANANA PLUG CONVERTOR ADAPTER
52-5680-15	BIPOLAR CABLE ADAPTER FOR KLEPPINGER FORCEPS CABLES
52-5680-16	BIPOLAR CABLE ADAPTER FOR 2-PIN PLUG CABLES
52-5680-17	ALLIGATOR TEST CLIP FOR ENDO-TESTER
52-5685-10	INSULATED HANDLE TEST ELECTRODE W/ ATTACHED CABLE, FOR USE W/ INSULATION TEST ELECTRODE



Supplies For Laparoscopic Procedures & Instrument Maintenance



LIST NO. 52003-80	WATER JET CLEANING GUN FOR CONNECTION TO
----------------------	--

The Instrument Cleaning Kit is an effective and easy-to-use solution to your laparoscopic instrumentation cleaning needs. It was designed with your convenience in mind.

The Instrument Cleaning Kit consists of List No. 52003-80 & List No. 52003-81

- A) SHEATHS AND INSERTS, SYRINGES, INJECTION CANNULA
 - B) SHEATHS, PIPETTES
 - C) CATHETERS
 - D) DRAINAGE TUBES
 - E) COCKS, CANNULA AND SYRINGES
 - F) BOTTLES
 - G) DOUCHE FITTINGS
 - H) WATER JET PUMP
- (ALSO SUITABLE FOR DRYING IN CONJUNCTION W/ THE FITTINGS)

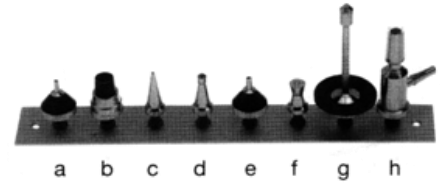

LIST NO. 52003-81	SET OF ADAPTERS FOR THE CLEANING OF (A) THROUGH (H)
----------------------	---

ULTRASTOP "PRO MED" ANTI-FOGGING AGENT



Ultrastop is the most cost-effective method of protecting your medical optics from fogging up: it eliminates the need to warm up your endoscopes prior to use; and due to its

LIST NO. 52003-37	ULTRASTOP, PER DOZEN BOTTLES
LIST NO. 52003-38	ULTRASTOP, PER BOTTLE

LUBRICATING OIL FOR SURGICAL INSTRUMENTS



To maintain high quality of costly surgical instrument joints and other components, a light application of surgical instruments should be made prior to sterilization

LIST NO. 52003-39	ONE DOZEN, 0.5 OZ EACH, NON-STERILE
LIST NO. 52003-40	ONE BOTTLE, 0.5 OZ. EACH, NON-STERILE

CLEANING BRUSHES FOR ENDOSCOPIC INSTRUMENTS



LIST NO. (QTY. 10)	STAINLESS STEEL WIRE AND ANTI-MICROBIAL BRUSHES MADE IN THE USA	LIST NO. (QTY. 1)
52003-56	2 MM Ø FOR 2MM Ø CANNULAS (12" LONG)	52003-57
52003-21	4 MM Ø FOR 3, 4 MM Ø CANNULAS (TROCAR SLEEVES, ETC) 12" LONG	52003-22
52003-23	6 MM Ø FOR 5, 6 MM Ø CANNULAS (TROCAR SLEEVES, ETC) 12" LONG	52003-24
52003-25	8 MM Ø FOR 7, 8 MM Ø CANNULAS (TROCAR SLEEVES, ETC) 12" LONG	52003-26
52003-27	12 MM Ø FOR 10, 11, 12 MM Ø CANNULAS (TROCAR SLEEVES, ETC) 12" LONG	52003-28
52003-29	4 MM Ø FOR 3, 4 MM Ø CANNULAS (SINGLE PUNCTURE LAPAROSCOPE, ETC) 19" LONG	52003-30
52003-31	6 MM Ø FOR 5, 6 MM Ø CANNULAS (S.P. LAPAROSCOPE, BIPOLAR FCPS, ETC) 19" LONG	52003-32
52003-33	8 MM Ø FOR 7, 8 MM Ø CANNULAS (S.P. LAPAROSCOPE, SUCTION TUBES, ETC) 19" LONG	52003-34
52003-48	12 MM Ø FOR 10, 11, 12 MM Ø CANNULAS (LAP. INSTR, SUCTION TUBES, ETC) 19" LONG	52003-49
52003-35	VERRES NEEDLES (8" LONG)	52003-36
52003-41	NYLON BRISTLE BRUSH WITH HANDLE 7" LONG 52003-43	52003-42
52003-45	STAINLESS STEEL BRISTLE BRUSH WITH HANDLE 7" LONG	52003-47
52003-54	DOUBLE END NYLON BRISTLE BRUSH W/HANDLE FOR LAPAROSCOPIC INST. 7" LONG	52003-55



Sterilization & Storage Containers For Lap Instruments & Scopes

NEW FROM AMERISURG!!!

Light Weight Aluminum Sterilization & Storage Containers That Can Hold Up To 16 Instruments (also available with a removable tray for general instruments as well)

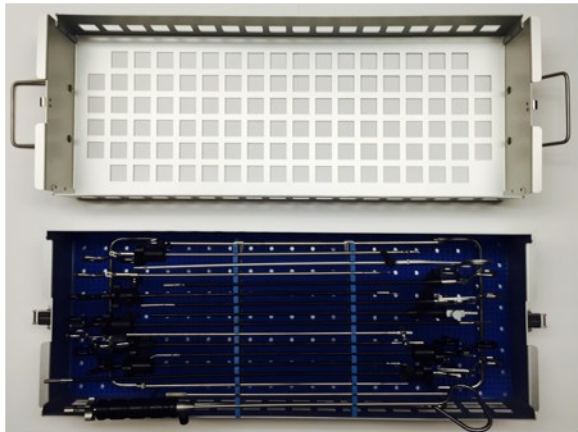

LIST NO. 52038-48	ALUMINUM LIGHTWEIGHT LAP INSTRUMENT STERILIZATION & STORAGE CONTAINER FOR 33CM & 45CM INSTRUMENTS; HOLDS UP TO (16) 5MM & 10MM DIAMETER INSTRUMENTS (26" X 10" X 7")
----------------------	--

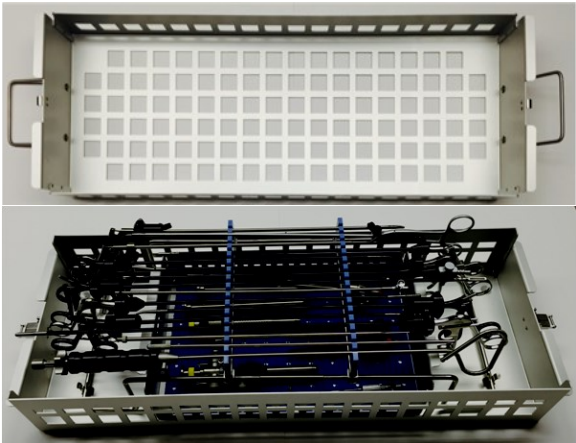

LIST NO. 52038-49	ALUMINUM LIGHTWEIGHT LAP INSTRUMENT STERILIZATION & STORAGE CONTAINER FOR 33CM & 45CM INSTRUMENTS; HOLDS UP TO (16) 5MM & 10MM DIAMETER INSTRUMENTS ALONG WITH TAKE OUT TRAY FOR MISC. INSTRUMENTS (26" X 10" X 7")
----------------------	---



LIST NO. 52038-53	LAP INSTRUMENT STERILIZATION & STORAGE CONTAINER FOR 33CM INSTRUMENTS; HOLDS UP TO (12) 5MM & 10MM DIAMETER INSTRUMENTS (MOLDED MEDICAL GRADE POLYMER, 21" X 10" X 4")
----------------------	--

LIST NO. 52038-54	LAP INSTRUMENT STERILIZATION & STORAGE CONTAINER FOR 45CM INSTRUMENTS; HOLDS UP TO (16) 5&10MM DIAMETER INSTRUMENTS (MOLDED MEDICAL GRADE POLYMER, 25" X 12" X 5")
----------------------	--



LIST NO. 52038-51	LAP INSTRUMENT CONTAINER W/ REMOVABLE TRAY FOR 33CM INSTRUMENT HOLDS UP TO (12) 5MM & 10MM DIAMETER INSTRUMENTS (MOLDED MEDICAL GRADE POLYMER & SILICONE, 21" X 10" X 7")
----------------------	---

LIST NO. 52038-52	LAP INSTRUMENT CONTAINER W/ REMOVABLE TRAY FOR 45CM INSTRUMENTS; HOLDS UP TO (10) 5&10MM DIAMETER INSTRUMENTS (MOLDED MEDICAL GRADE POLYMER & SILICONE, 26" X 9 1/2" X 7")
----------------------	--



Sterilization & Storage Containers For Lap Instruments & Scopes



LIST NO. 52037-00-B4	ALUMINUM STERILIZATION CONTAINER 25" X 5" X 2", W/ 4 BARS
-------------------------	--

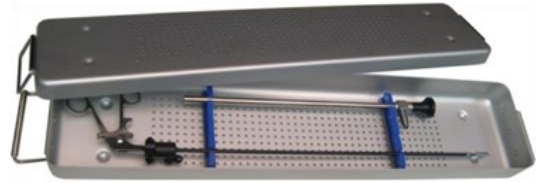

LIST NO. 52037-00-B2	ALUMINUM STERILIZATION CONTAINER 25" X 5" X 2", W/ 2 BARS
-------------------------	--



LIST NO. 52037-07	THERMOPLASTIC STERILIZATION & STORAGE CONTAINER W/ SILICONE MOUNTING BARS FOR MULTIPLE LAP/HYSTO/CYSTO SCOPE OR SINGLE HYST/CYST SHEATH SYSTEM, (MOLDED MEDICAL-GRADE POLYMER & SILICONE), 18"L X 7"W X 1.5"H
----------------------	---



LIST NO. 52037-06	THERMOPLASTIC STERILIZATION & STORAGE CONTAINER FOR 2 LAP/HYSTO/CYSTO SCOPES OR SINGLE HYST/CYST SHEATH SYSTEM, (MOLDED MEDICAL-GRADE POLYMER & SILICONE), 18"L X 3"W X 1.5"H
----------------------	---

ALSO AVAILABLE, BUT NOT PICTURED...

LIST NO. 52037-05	THERMOPLASTIC STERILIZATION & STORAGE CONTAINER FOR SINGLE LAP/HYSTO/CYSTO SCOPE OR SINGLE HYST/CYST SHEATH SYSTEM (MOLDED MEDICAL-GRADE POLYMER & SILICONE) 18"L X 3"W X 1.5"H
LIST NO. 52037-08	THERMOPLASTIC STERILIZATION & STORAGE CONTAINER (DOUBLE HEIGHT) FOR MULTIPLE LAP/HYSTO/CYSTO SCOPE OR SINGLE HYST/CYST SHEATH SYSTEM, (MOLDED MEDICAL-GRADE POLYMER & SILICONE), 18"L X 7"W X 3"H
LIST NO. 52038-15	STERILIZATION & STORAGE CONTAINER FOR EXTRA-LONG SCOPE & CABLE, 25" X 6" X 1.5" (MOLDED MEDICAL-GRADE POLYMER & SILICONE); HOLDS 2 SCOPES UP TO 50CM LONG
LIST NO. 52037-11	MUSLIN CLOTH FOR 52037-00 & 52037-01 CONTAINER